

**Manual**  
**Air Jet Sieving Machine AS 200 jet**

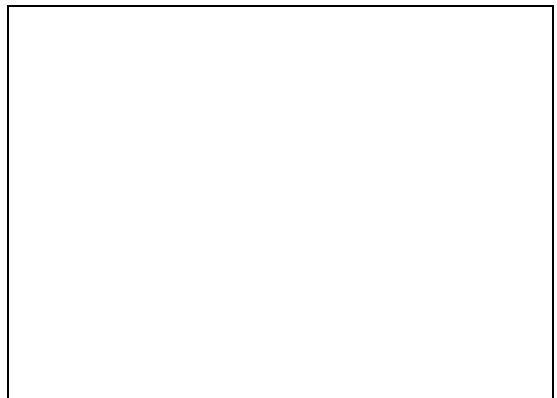

Translation



**Copyright**

© Copyright by  
Retsch GmbH  
Retsch-Allee 1-5  
42781 Haan  
Germany

## Table of Contents

<b>1</b>	<b>Notes on the Manual .....</b>	<b>6</b>
1.1	Disclaimer .....	6
1.2	Copyright.....	6
1.3	Explanations of the Safety Instructions .....	7
1.4	General Safety Instructions .....	8
1.5	Repairs.....	9
<b>2</b>	<b>Confirmation Form for the Managing Operator.....</b>	<b>10</b>
<b>3</b>	<b>Technical Data .....</b>	<b>11</b>
3.1	Degree of Protection.....	11
3.2	Emissions.....	11
3.3	Electromagnetic Compatibility (EMC).....	11
3.4	Rated Power .....	11
3.5	Dimensions and Weight.....	12
3.6	Required Floor Space.....	12
3.7	Receptacle Volume.....	12
3.8	Feed Grain Size.....	13
3.9	Negative Pressure .....	13
3.10	Payload.....	13
3.11	Suitable Sieve Diameters .....	13
<b>4</b>	<b>Packaging, Transport and Installation .....</b>	<b>14</b>
4.1	Packaging .....	14
4.2	Transport.....	14
4.3	Temperature Fluctuations and Condensation .....	14
4.4	Conditions for the Installation Site .....	15
4.5	Electrical Connection .....	15
4.6	Type Plate Description.....	16
4.7	Installation of the Device.....	17
<b>5</b>	<b>First Commissioning.....</b>	<b>18</b>
5.1	Silencer .....	18
5.2	Manual Vacuum Regulation.....	19
5.2.1	Connecting the Manual Vacuum Regulation .....	20
5.2.2	Adjustment of the Manual Vacuum Regulation .....	20
5.3	Automatic Vacuum Regulation .....	21
5.4	Connecting an Industrial Vacuum Cleaner .....	22
5.5	Inserting the Test Sieve .....	23
5.5.1	Sieve Lids .....	24
<b>6</b>	<b>Operating the Device .....</b>	<b>26</b>
6.1	Use of the Device for the Intended Purpose.....	26
6.2	Principle of Operation .....	27
6.3	Views of the Instrument .....	28
6.3.1	Front.....	28
6.3.2	Back .....	29
6.4	Switching On / Off.....	30
6.5	Standby Mode.....	30
6.6	Performing a Sieving .....	30
6.6.1	Soft-faced Mallet.....	31
<b>7</b>	<b>Controlling the Device .....</b>	<b>32</b>
7.1	Operating Controls, Displays and Functions .....	32
7.2	Operating Modes and Navigation .....	33
7.2.1	Navigation between Operating Modes .....	33
7.3	Sieving Parameters .....	33
7.3.1	Adjustable Parameters .....	33

7.3.2	Activatable or Deactivatable Parameters .....	34
7.4	Manual Mode .....	35
7.4.1	Start Process .....	36
7.4.2	Stop Process.....	36
7.5	Quick Start .....	36
7.6	Programme Mode .....	37
7.6.1	Select a Programme .....	37
7.6.2	Edit a Programme .....	37
7.6.3	Save a Programme .....	38
7.6.4	Delete a Programme.....	38
7.7	Basic Settings .....	38
7.7.1	Negative Pressure .....	38
7.7.2	Languages .....	39
7.7.3	Brightness .....	39
7.7.4	Date .....	39
7.7.5	Time .....	40
7.7.6	Signal Tone.....	40
7.7.7	Interface .....	40
7.7.8	Service .....	41
<b>8</b>	<b>EasySieve® .....</b>	<b>43</b>
<b>9</b>	<b>Error Messages and Information Notes .....</b>	<b>44</b>
9.1	Error Messages .....	44
9.2	Information Notes .....	44
<b>10</b>	<b>Return for Service and Maintenance .....</b>	<b>45</b>
<b>11</b>	<b>Cleaning, Wear and Maintenance .....</b>	<b>46</b>
11.1	Cleaning.....	46
11.1.1	Cleaning of Test Sieves.....	46
11.1.1.1	Cleaning of Test Sieves with Mesh Sizes > 500 µm .....	47
11.1.1.2	Cleaning of Test Sieves with Mesh Sizes < 500 µm .....	47
11.1.1.3	Drying of Test Sieves.....	47
11.2	Wear .....	47
11.3	Maintenance .....	48
11.4	Calibration of the Pressure Sensor.....	48
<b>12</b>	<b>Accessories .....</b>	<b>50</b>
12.1	Automatic Vacuum Regulation .....	50
12.2	Connecting the Automatic Vacuum Regulator.....	50
12.3	Adjustment of the Automatic Vacuum Regulation .....	51
12.4	Cyclone Separator.....	52
12.4.1	Connecting the Cyclone Separator.....	53
12.5	Test Sieves .....	54
12.5.1	Certificate.....	55
12.5.2	Calibration Service.....	55
<b>13</b>	<b>Disposal.....</b>	<b>56</b>
<b>14</b>	<b>Index .....</b>	<b>57</b>



## 1 Notes on the Manual

**Dear user,**

please read the following manual referring to this device carefully before starting any installation, commissioning and operation.

This manual is a technical guide on how to operate the device safely and it contains all the information required for the areas specified in the table of contents. This technical documentation is a reference and instruction manual. The individual chapters are complete in themselves. Familiarity (of the respective target groups defined per area) with the relevant chapters is a precondition for the safe and appropriate use of the device.

This manual does not contain any repair instructions. In case of any obscurities or questions with regards to this document or the device, as well as if faults arise or repairs are necessary, please contact your supplier or get in touch with Retsch GmbH directly.

Application-technical information relating to samples to be processed are not or only to a certain extent included. However, more information thereof can be found in the internet on the webpage of the respective device on the Retsch GmbH homepage (<http://www.retsch.com>).

**Revision status:**

This document revision 0015 refers to the manual "Air Jet Sieving Machine AS 200 jet" in compliance with the Directive of Machinery 2006/42/EC.

### 1.1 Disclaimer

This document has been prepared with due care. Technical and software based modifications are reserved. No liability is assumed for data loss, personnel injury or damage to the device which results from the failure to observe the instructions and/or warnings in this document.

### 1.2 Copyright

This document or parts of it or its content may not be reproduced, distributed, edited or copied in any form without prior written permission of Retsch GmbH. Damage claims shall be asserted in the case of infringements.

### 1.3 Explanations of the Safety Instructions

In this document the following **signs and symbols** are being used:

①	Reference to a recommendation and/or an important information
→	Reference to a chapter, table or figure
⇒	Action instruction
Name	Software menu function
[Name]	Software button
(Name)	Software checkbox

In this document the following **safety instructions** warn of possible dangers and damages:

 <b>DANGER</b>	<i>D1.0000</i>
<p><b>Type of danger / personal injury</b> Source of danger</p> <ul style="list-style-type: none"> <li>– Possible consequences if the dangers are not observed.</li> <li>• <b>Instructions and information on how the dangers are to be avoided.</b></li> </ul>	

**Life-threatening personal injuries** may result from disrespecting the safety instruction for danger. There exists a **very high risk** of hazard of life or permanent injury to personnel. Additionally, in continuous text or action instructions the signal word ** DANGER** is used.

 <b>WARNING</b>	<i>W1.0000</i>
<p><b>Type of danger / personal injury</b> Source of danger</p> <ul style="list-style-type: none"> <li>– Possible consequences if the dangers are not observed.</li> <li>• <b>Instructions and information on how the dangers are to be avoided.</b></li> </ul>	

**Serious personal injuries** may result from disrespecting the warning notice. There exists an **elevated risk** of an accident or severe or possibly fatal injury to personnel. Additionally, in continuous text or action instructions the signal word ** WARNING** is used.

 <b>CAUTION</b>	<i>C1.0000</i>
<p><b>Type of danger / personal injury</b> Source of danger</p> <ul style="list-style-type: none"> <li>– Possible consequences if the dangers are not observed.</li> <li>• <b>Instructions and information on how the dangers are to be avoided.</b></li> </ul>	

**Moderate or mild personal injuries** may result from disrespecting the safety instruction for caution. There exists a medium or low risk of an accident or injury to personnel. Additionally, in continuous text or action instructions the signal word ** CAUTION** is used.

**NOTICE**

N1.0000

**Type of property damage**

Source of property damage

- Possible consequences if the notices are not observed.
- **Instructions and information on how the property damages are to be avoided.**

**Property damages** may result from disrespecting the notice. However, there exists no risk of an injury to personnel. Additionally, in continuous text or action instructions the signal word **NOTICE** is used.

**1.4 General Safety Instructions**

**⚠ CAUTION**

C2.0002

**Read the manual**

Non-observance of the manual

- The non-observance of this manual can result in personal injuries.
- **Read the manual before using the device.**



**Target group:**

All persons concerned with this device in any form.

This device is a modern, high performance product from Retsch GmbH and complies with the state of the art. Operational safety is given if the device is handled for the intended purpose and attention is given to this technical documentation.

**Safety manager:**

The managing operator himself must ensure that the people entrusted with working on the device...

- have noted and understood all the regulations regarding safety,
- are familiar before starting work with all the operating instructions and specifications for the target group relevant to their work,
- have unrestricted and free access to the technical documentation of this device,
- are familiar before starting work with the safe handling of the device and its use for its intended purpose either by verbal instructions from a competent person and/or by means of this technical documentation.

**⚠ CAUTION** Improper operation can result in personal injuries and material damage. The managing operator himself is responsible for his own safety and that of his employees. The managing operator himself is responsible that no unauthorised person has access to the device.

**⚠ CAUTION** Persons who are under the influence of intoxicating substances (pharmaceuticals, drugs, alcohol), fatigue or health disorders must not operate the device.

**CAUTION**

C3.0015

**Changes to the device**

Improper modifications

- Changes to the device can lead to personal injuries.
- **Do not make any modification to the device.**
- **Use spare parts and accessories that have been approved by Retsch GmbH exclusively.**

**NOTICE**

N2.0012

**Changes to the device**

Improper modifications

- The conformity declared by Retsch GmbH with the European Directives will lose its validity.
- Any warranty claims will be terminated.
- **Do not make any modification to the device.**
- **Use spare parts and accessories that have been approved by Retsch GmbH exclusively.**



## 1.5 Repairs

This manual does not contain any repair instructions. For safety reasons, repairs may only be carried out by Retsch GmbH or an authorised representative or by qualified service technicians.

**In case of repair, please inform...**

- ...the Retsch GmbH representative in your country,
- ...your supplier, or
- ...Retsch GmbH directly.

**Service address:**

## 2 Confirmation Form for the Managing Operator

This manual contains essential instructions for operating and maintaining the device which must be strictly observed. It is essential that they be read by the user and by the qualified staff responsible for the device before the device is commissioned. This manual must be available and accessible at the place of use at all times.

The user of the device herewith confirms to the managing operator (owner) that he has received sufficient instructions about the operation and maintenance of the system. The user has received the manual, has read and taken note of its contents and consequently has all the information required for safe operation and is sufficiently familiar with the device.

The managing operator should for legal protection have the user confirm the instruction about the operation of the device.

I have read and taken note of the contents of all chapters in this manual as well as all safety instructions and warnings.

**User**

Surname, first name (block letters)

Position in the company

Place, date and signature

**Managing operator or service technician**

Surname, first name (block letters)

Position in the company

Place, date and signature

### 3 Technical Data

#### 3.1 Degree of Protection

- IP40

#### 3.2 Emissions

**⚠ CAUTION**

C4.0050

**Possibility of acoustic signals not being heard**

Loud suction noises

- Possible acoustic alarms and voice communication might not be heard.
- **Consider the volume of the suction noises in relation to other acoustic signals in the work environment. Additional visual signals may be used.**

**⚠ CAUTION**

C5.0046

**Hearing damage**

Due to suction noises at the suction opening a high sound level may be generated

- Excessive noise in terms of level and duration can cause impairments or permanent damage to hearing.
- **Ensure suitable noise protection measures are taken or wear ear protection.**



**Sound parameters:**

The AS 200 jet itself causes, due to its construction, almost no significant noise emission.

The sound parameters of the connected industrial vacuum cleaner depend on the set suction power.

Example:

Industrial vacuum cleaner:	Nilfisk HDS 2000
Suction level:	2

At these operating conditions, the workplace related equivalent continuous sound level  $L_{eq} = 72 \text{ dB(A)}$ .

#### 3.3 Electromagnetic Compatibility (EMC)

- EMC class according to DIN EN 55011: B

#### 3.4 Rated Power

~ 50 W (VA)

The rated power of the AS 200 jet including an industrial vacuum cleaner (e.g. Nilfisk HDS 2000) amounts max. 1 450 W (VA).

### 3.5 Dimensions and Weight

- Height: 288 mm
- Height with test sieve (50 mm): ~ 382 mm
- Width: 460 mm
- Width with cyclone separator: ~ 665 mm
- Depth: 302 mm
- Depth with manual vacuum regulation: ~ 392 mm
- Depth with automatic vacuum regulation: ~ 418 mm
- Weight: ~ 15 kg

### 3.6 Required Floor Space

**⚠ CAUTION**

C6.0047

**Falling down of the device**

Incorrect positioning or insufficient working space

- Due to its weight, the device can inflict personal injury if it falls down.
  - **The device must only be operated on a sufficiently large, strong and stable workplace.**
  - **All feet of the device must be positioned securely.**

- Width of the base: 480 mm  
680 mm (with cyclone separator)
- Depth of the base: 460 mm
- No safety clearances required

**Location requirements:**

The device must be placed on a vibration-free, plane, stable and free surface to avoid transmission of vibrations. A level base ensures the uniform distribution of the sample over the sieve mesh fabric, as well as the stability of the device.

### 3.7 Receptacle Volume

The maximum receptacle volume (the maximum feed quantity) depends on various factors such as aperture size of the test sieve, maximum grain size and width of distribution of the sample material.

Examples for the maximum feed quantity according to DIN 66165 for test sieves of 200 mm in diameter are listed in the following table:

Mesh size	Max. feed quantity	Max. permitted oversize material according to DIN 66165
25 µm	14 cm <sup>3</sup>	7 cm <sup>3</sup>
45 µm	20 cm <sup>3</sup>	10 cm <sup>3</sup>
63 µm	26 cm <sup>3</sup>	13 cm <sup>3</sup>
125 µm	38 cm <sup>3</sup>	19 cm <sup>3</sup>
250 µm	58 cm <sup>3</sup>	29 cm <sup>3</sup>
500 µm	88 cm <sup>3</sup>	44 cm <sup>3</sup>
1 mm	126 cm <sup>3</sup>	63 cm <sup>3</sup>

2 mm	220 cm <sup>3</sup>	110 cm <sup>3</sup>
4 mm	346 cm <sup>3</sup>	173 cm <sup>3</sup>
8 mm	566 cm <sup>3</sup>	283 cm <sup>3</sup>

### 3.8 Feed Grain Size

Traditional dry sieving is performed in the particle size range of 40 µm to 125 mm. By means of sieving aids or with wet sieving the measurement range can be extended to 20 µm. The maximum feed grain size depends on the sample material, the number and aperture size of the test sieves and the type of the sieving machine.

Examples for the maximum feed grain size according to DIN 66165 are listed in the following table:

Mesh size	Max. feed grain size according to DIN 66165	Mesh size	Max. feed grain size according to DIN 66165
22 µm	710 µm	4 mm	25 mm
45 µm	1 mm	8 mm	45 mm
63 µm	1.4 mm	16 mm	71 mm
125 µm	2.5 mm	22.4 mm	90 mm
250 µm	4 mm	45 mm	150 mm
500 µm	6 mm	63 mm	180 mm
1 mm	10 mm	90 mm	230 mm
2 mm	16 mm	125 mm	300 mm

The Air Jet Sieving Machine AS 200 jet is designed for the measurement range of 10 µm to 4 mm.

### 3.9 Negative Pressure

**NOTICE** The maximum negative pressure, generated by an industrial vacuum cleaner or an external suction device must be < 100 mbar (10 000 Pa or 1.45 psi)!

### 3.10 Payload

Depending on the mesh size of the test sieve used (→ Chapter "[Receptacle Volume](#)") and the density of the sample material, the maximum payload is 0.3 – 100 g.

**NOTICE** If the test sieve is overloaded, it can be damaged as the sample material clogs the meshes and the negative pressure can thus exert too much force on the sieve mesh fabric.

### 3.11 Suitable Sieve Diameters

- Suitable sieve diameters: 200 mm / 203 mm (8")

## 4 Packaging, Transport and Installation

### 4.1 Packaging

The packaging has been adapted to the mode of transport. It complies with the generally applicable packaging guidelines.

#### NOTICE

N3.0001

##### Storage of the packaging

- In the event of a complaint or return, the warranty claim may be endangered if the packaging is inadequate or the device has not been secured correctly.
- **Keep the packaging for the duration of the warranty period.**

### 4.2 Transport

#### NOTICE

N4.0017

##### Transport

- Mechanical or electronic components may be damaged.
- **The device may not be knocked, shaken or thrown during transport.**

#### NOTICE

N5.0014

##### Complaints

Incomplete delivery or transport damage

- The forwarding agent and Retsch GmbH must be notified immediately in the event of transport damage. It is otherwise possible that subsequent complaints will not be recognised.
- **Please check the delivery on receipt of the device for its completeness and intactness.**
- **Notify your forwarding agent and Retsch GmbH within 24 hours.**

### 4.3 Temperature Fluctuations and Condensation

#### NOTICE

N6.0016

##### Temperature fluctuations

The device may be subject to strong temperature fluctuations during transport (e.g. aircraft transport)

- The resultant condensed water may damage electronic components.
- **Wait before commissioning until the device has been acclimatised.**

##### Temporary storage:

Also in case of an interim storage the device must be stored dry and within the specified ambient temperature range.

#### 4.4 Conditions for the Installation Site

- Installation height: max. 2 000 m above sea level
- Ambient temperature: 5 °C – 40 °C

##### NOTICE

N7.0021

##### Ambient temperature

Temperatures outside the permitted range

- Electronic and mechanical components may be damaged.
  - The performance data alter to an unknown extent.
  - **Do not exceed or fall below the permitted temperature range (5 °C to 40 °C ambient temperature) of the device.**
- Maximum relative humidity < 80 % (at ambient temperatures ≤ 31 °C)

For ambient temperatures  $U_T$  between 31 °C and 40 °C, the maximum relative humidity value  $L_F$  linearly decreases according to  $L_F = -(U_T - 55) / 0.3$ :

Ambient temperature	Max. rel. humidity
≤ 31 °C	80 %
33 °C	73.3 %
35 °C	66.7 %
37 °C	60 %
39 °C	53.3 %
40 °C	50 %

##### NOTICE

N8.0015

##### Humidity

High relative humidity

- Electronic and mechanical components may be damaged.
- The performance data alter to an unknown extent.
- **The relative humidity in the vicinity of the device should be kept as low as possible.**

#### 4.5 Electrical Connection

##### WARNING

W2.0015

##### Danger to life through electric shock

Connection to sockets without protective earth

- An electric shock can cause burns, cardiac arrhythmia, respiratory arrest, as well as cardiac arrest.
- **The device may only be operated on sockets with protective earth (PE).**



**NOTICE**

**Electrical connection**

Failure to observe the values on the type plate

- Electronic and mechanical components may be damaged.
- **Connect the device only to a mains supply matching the values on the type plate.**

**⚠ WARNING** When connecting the power cable to the mains supply, use an external fuse that complies with the regulations applicable to the place of installation.

- Check the type plate for details on the necessary voltage, frequency, and maximum external current source fuse for the device.
- The listed values must agree with the existing mains supply.
- Only use the supplied power cable to connect the device to the mains supply.

**NOTICE** The external fuse must amount 16 A (delay-action).

**4.6 Type Plate Description**

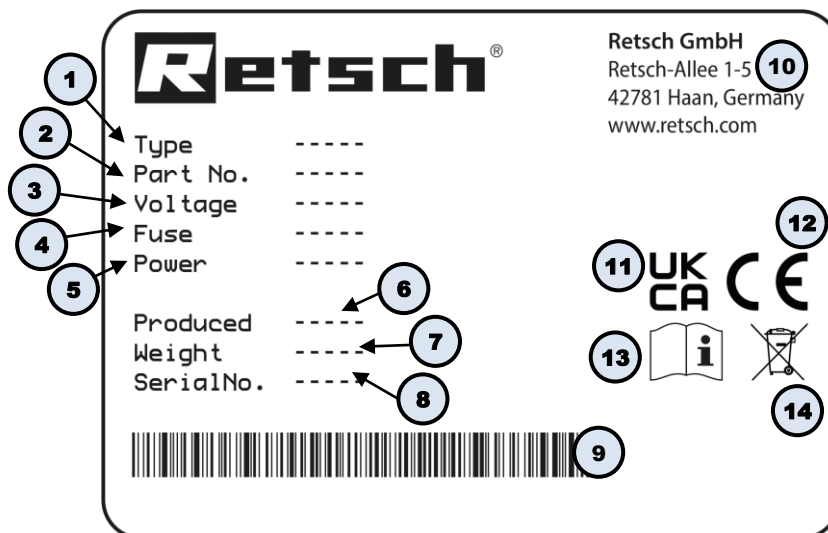

Fig. 1: Type plate

- 1 Device designation
- 2 Part number
- 3 Power version, Mains frequency
- 4 Fuse type and fuse strength
- 5 Capacity, Amperage
- 6 Year of production
- 7 Weight
- 8 Serial number
- 9 Bar code
- 10 Manufacturer's address
- 11 UKCA marking
- 12 CE marking
- 13 Safety warning: Read the manual
- 14 Disposal label

- ① In the case of queries please provide the device designation (1) or part number (2), as well as the serial number (8) of the device.

## 4.7 Installation of the Device

**⚠ WARNING** W3.005

**Serious personal injury**  
Falling loads

- Due to the heavy weight of the device, serious personal injuries can be caused if it falls down.
- **Lifting above head height is not permissible!**



**NOTICE** N10.0051

**Suction of objects**  
Suction opening of the silencer

- Smaller objects can be sucked into the interior of the device.
- **Make sure that no objects are placed near the suction opening.**

To generate the necessary negative pressure in the nozzle chamber, the AS 200 jet sucks the required air through the silencer (F) during operation.

- ⇒ Make sure that the suction opening of the silencer is always kept clear and that the air can be sucked in unhindered!

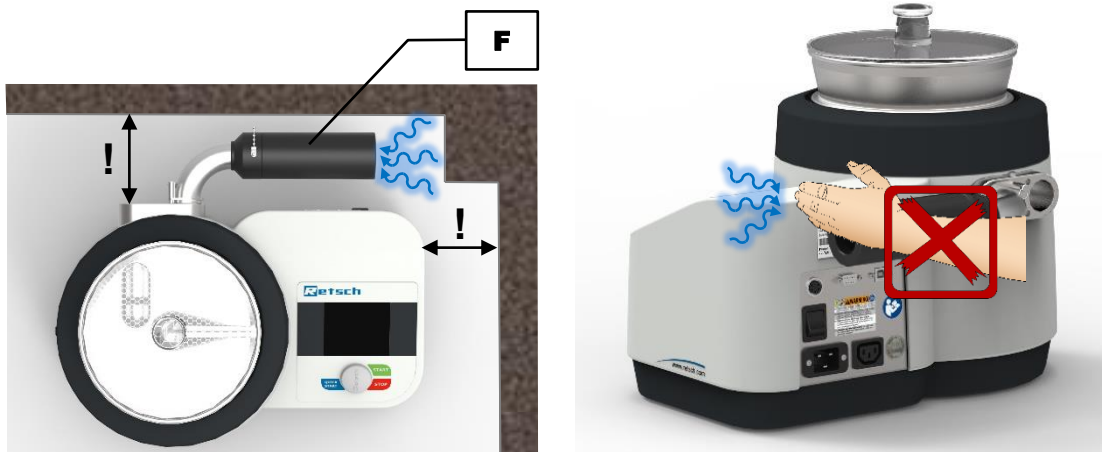

Fig. 1: Installation of the device: keep the suction opening clear!

## 5 First Commissioning

**WARNING**

W4.0002

**Danger to life through electric shock**  
 Damaged power cable

- An electric shock can cause burns, cardiac arrhythmia, respiratory arrest, as well as cardiac arrest.
- **Never use a damaged power cable to connect the device to the mains!**
- **Check the power cable and the plug for any damage before use.**

**NOTICE**

**Setting up the device**  
 Disconnecting the device from the mains

- A separation of the device from the mains must be possible at any time.
- **Set up the device in such a way, that the connection for the power cable is always easily accessible.**

N11.0002

Before first commissioning the silencer and the manual or automatic vacuum regulation must be installed, and an industrial vacuum cleaner must be connected.

Subsequently, the desired test sieve with the appropriate lid can be inserted. The AS 200 jet is suitable for test sieves with an outer diameter of 200 mm (with adapter ring) and 203 mm.

**NOTICE** Only one test sieve must be inserted. A large amount of sample can significantly increase the load on the sieve mesh fabric. Make sure not to exceed the maximum payload (→ Chapter "[Payload](#)").

### 5.1 Silencer

To reduce the suction noise, it is recommended to mount the silencer (F) included in the delivery to the air inlet duct (D).

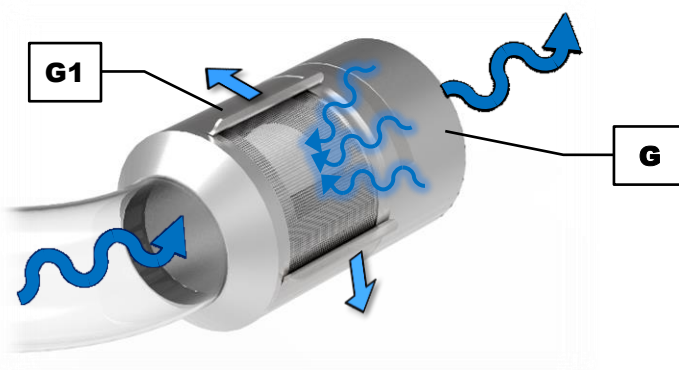

**Fig. 2:** Mounting the silencer

- ⇒ Insert the silencer (F) into the air inlet duct (D).
- ⇒ Insert the positioning pin (F1) into the upper opening to fix the silencer in a horizontal position.

## 5.2 Manual Vacuum Regulation

The manual vacuum regulation (G) is contained in the scope of delivery. It allows for the regulation of the negative pressure by means of a manually adjustable slider (G1).



**Fig. 3:** Functional principle of the manual vacuum regulation

### 5.2.1 Connecting the Manual Vacuum Regulation



**Fig. 4:** Mounting the manual vacuum regulation

⇒ Insert the manual vacuum regulation (**G**) into the air outlet duct (**E**).

### 5.2.2 Adjustment of the Manual Vacuum Regulation

The manual vacuum regulation (**G**) has a lateral opening (**G2**) through which air is sucked in. The size of the opening can be varied by means of a slider (**G1**). This allows to adjust the desired negative pressure in the nozzle chamber (**A**).

When the opening is closed (**1**), the airflow from the nozzle (**B**) and thus also the negative pressure in the nozzle chamber is at maximum. With the opening at maximum (**4**), the airflow from the nozzle and thus the negative pressure in the nozzle chamber is at a minimum.

In between, the negative pressure can be infinitely adjusted by means of the slider (**G1**).

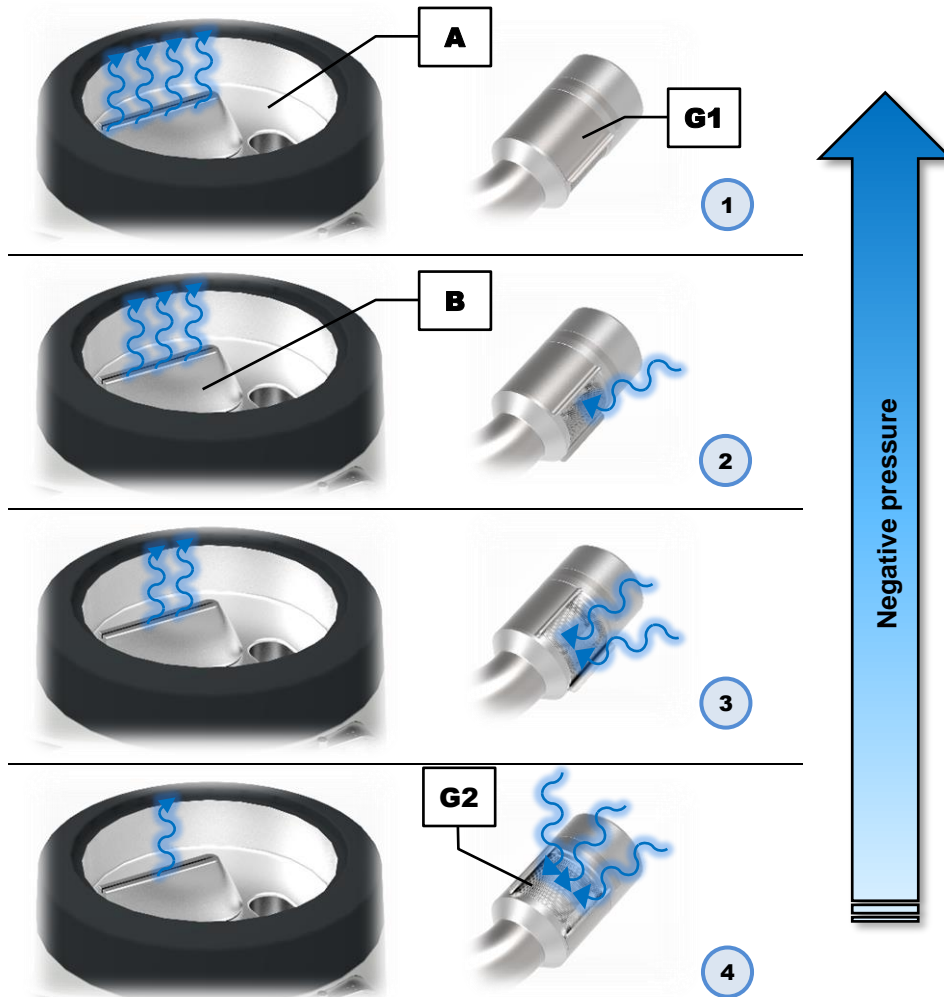

Fig. 5: Setting the manual vacuum regulation

The current negative pressure, i.e. the differential pressure between the air inlet and the air outlet is displayed in the operating control (**H**) (→ Chapter "[Controlling the Device](#)").

⇒ Use the slider (**G1**) to set the desired negative pressure.

### 5.3 Automatic Vacuum Regulation

The automatic vacuum regulation is available as an optional accessory from Retsch GmbH. A detailed description of the installation and operation can be found in the corresponding subchapter in Chapter "[Accessories](#)" or in the separate manual of the automatic vacuum regulation.

Whether an automatic vacuum regulation is connected or not is indicated by one of the following icons in the operating control (**H**):



Automatic vacuum regulation connected



No automatic vacuum regulation connected

**5.4 Connecting an Industrial Vacuum Cleaner**

⚠
WARNING
W5.0017

**Danger to life through electric shock**  
IEC power connection for external industrial vacuum cleaner

- When the device is switched on, there is a risk of an electric shock when touching the IEC power connection for the external industrial vacuum cleaner.
- An electric shock can cause burns, cardiac arrhythmia, respiratory arrest, as well as cardiac arrest.
- **Switch off the device before connecting the external industrial vacuum cleaner.**



⚠
CAUTION
C7.0049

**Danger of objects being ejected**  
Connection of compressed air instead of an industrial vacuum cleaner

- If compressed air is connected to one of the two air ducts, the sieve lid and the test sieve will be ejected.
- **The device may not be operated with compressed air!**

The AS 200 jet can only be operated with a suction device such as an industrial vacuum cleaner. A suitable industrial vacuum cleaner is available as an optional accessory from Retsch GmbH.

**NOTICE** When using other industrial vacuum cleaner models than the one recommended by Retsch GmbH, the device may become damaged.

**CAUTION** Before commissioning the industrial vacuum cleaner, read the corresponding separate manual.

Depending on the requirement, the industrial vacuum cleaner can either be connected to the air outlet duct (**E**) or the manual vacuum regulation (**G**) (recommended).

⇒ Connect the suction pipe (**SR**) of the industrial vacuum cleaner to the air outlet duct or alternatively to the manual vacuum regulation (recommended).

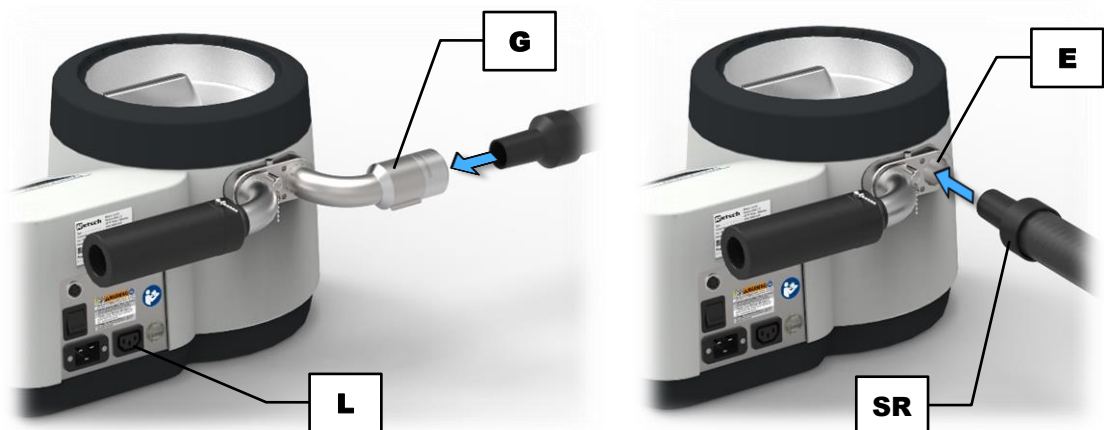

**Fig. 6:** Connecting the industrial vacuum cleaner: to the manual vacuum regulator (left, recommended) or the air outlet duct (right)

- ⇒ Insert the mains plug (IEC C14) of the industrial vacuum cleaner into the IEC power connection (L) on the backside of the AS 200 jet.
- ⇒ Switch on the industrial vacuum cleaner.

The industrial vacuum cleaner is supplied with power by the AS 200 jet and switched on automatically via software control at the beginning of the sieving process.

- ① The industrial vacuum cleaner connected to the IEC power connection (L) can also be used to [clean](#) the device. For that purpose, the industrial vacuum cleaner can be switched on manually via the control unit (→ Chapter "[Controlling the Device](#)").

**⚠ CAUTION**

**Chemical reactivity**

Mixing of different sample materials

- Successive analyses of different sample materials may cause unwanted chemical reactions that can lead to fires or explosions.
- **Do not analyse any sample materials in this device that carry a risk of increasing chemical reactivity by contact with a previously analysed substance.**
- **If in doubt, clean the device and the industrial vacuum cleaner (incl. changing the vacuum cleaner bag and filter) before analysing any other sample material.**
- **Observe the material safety data sheets of the sample materials.**

C8.0026



### 5.5 Inserting the Test Sieve

The AS 200 jet is designed for test sieves with an outer diameter of 203 mm (8") and a height of 50 mm (2") or 25 mm (1"). Test sieves with an outer diameter of 200 mm can also be used in combination with an adapter ring (AR).

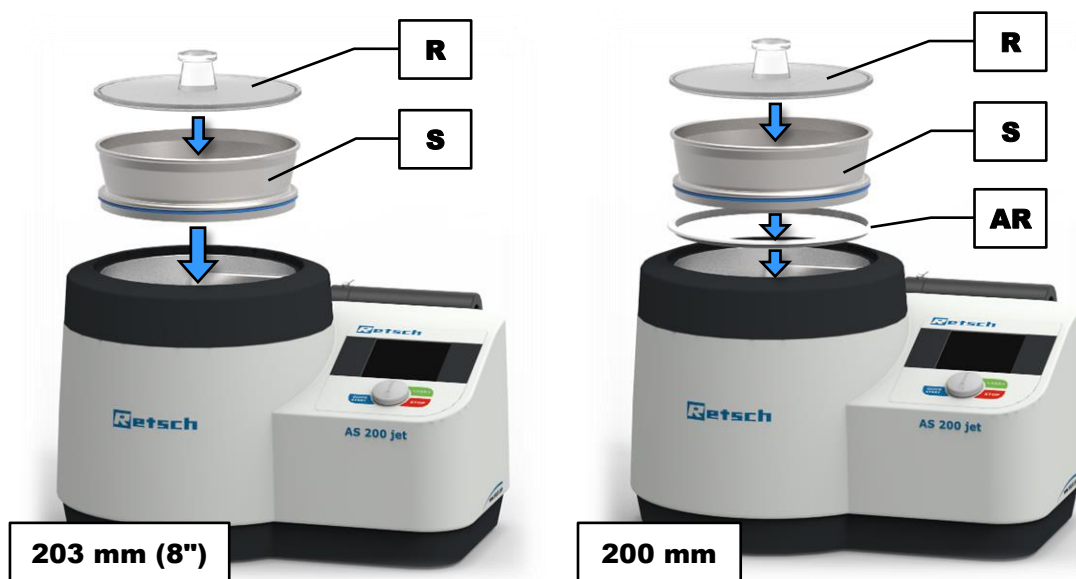

Fig. 7: Inserting a test sieve with an outer diameter of 203 mm (left) or 200 mm (right)

- ⇒ Place the desired test sieve (**S**) on the nozzle chamber (**A**). **NOTICE** For test sieves with 200 mm outer diameter, the adapter ring (**AR**) must be used additionally.
- ⇒ Place the sample material on the test sieve.
- ⇒ Close the test sieve with the sieve lid (**R**) suitable for the sieve height and outer diameter (→ Chapter "[Sieve Lids](#)").

**NOTICE** Only with a suitable combination of test sieve and sieve lid, the required negative pressure can be built up in the nozzle chamber and thus the sieving process can be started.

### 5.5.1 Sieve Lids

For the test sieves four different types of the sieve lid are available. These differ in their shape and their diameter, and must be chosen to match the test sieve used.

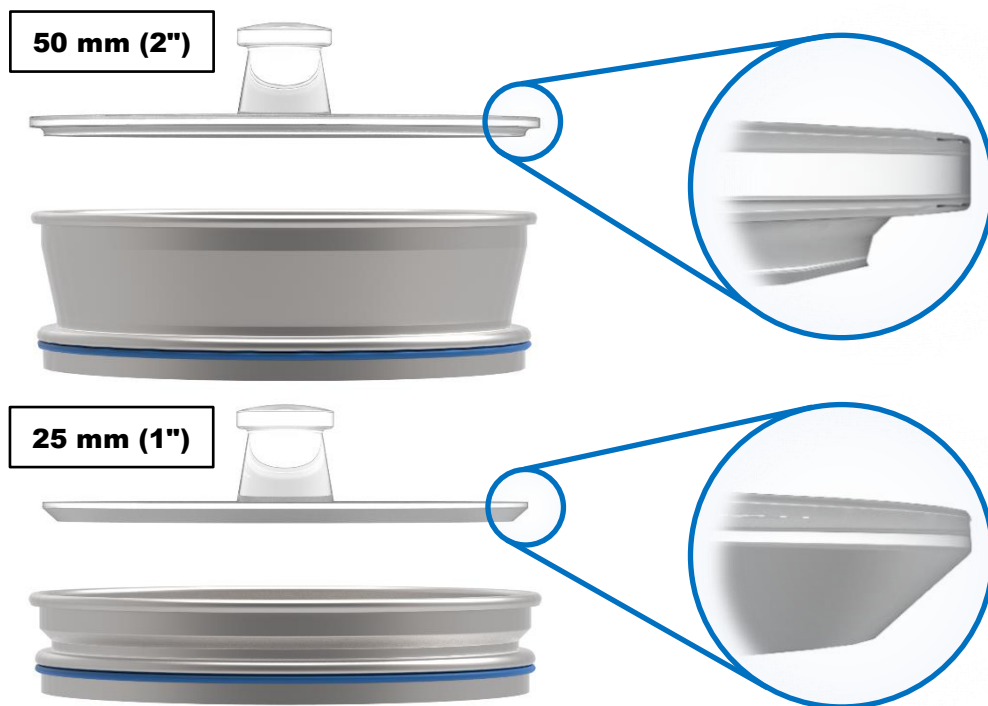

**Fig. 8:** Shape of the sieve lid for a sieve height of 50 mm (top) and 25 mm (bottom)

- ⇒ Pay attention to the appropriate labelling on the sieve lids:

Label	Outer diameter	Sieve height	Adapter ring
8 inch x 2 inch (50 mm)	203 mm (8")	50 mm (2")	no
8 inch x 1 inch (25 mm)	203 mm (8")	25 mm (1")	no
200 mm x 50 mm	200 mm	50 mm (2")	yes
200 mm x 25 mm	200 mm	25 mm (1")	yes



Fig. 9: Example of a label on the sieve lid

## 6 Operating the Device

### 6.1 Use of the Device for the Intended Purpose

**⚠ CAUTION**

C9.0005

**Risk of explosion or fire**

Potentially explosive atmosphere

- On account of its design, the device is not suitable for use in potentially explosive atmospheres.
- **Do not operate the device in a potentially explosive atmosphere.**

**⚠ CAUTION**

C10.0006

**Danger of personal injury**

Hazardous sample material

- Depending on the dangerous nature of the sample material necessary measures must be taken to rule out any danger of personal injury.
- **Observe the material safety data sheets of the sample material.**



**⚠ CAUTION**

C11.0003

**Risk of explosion or fire**

Changing sample properties

- The properties and therefore also the hazardousness of the sample can alter during the sieving process.
- **Do not use any substances in this device which carry the risk of explosion or fire.**
- **Observe the material safety data sheets of the sample material.**



This Air Jet Sieving Machine of the Retsch GmbH is a laboratory device. It is suitable for dry sieving of fine materials in the grain size range from 10 µm to 4 mm.

The particle size distribution of materials requiring efficient mixing and deagglomeration, such as chemical products, rubber, ceramics, cosmetics, plastics, food, minerals, pharmaceuticals, pigments, powder coatings, toner, washing powder and many other substances can be easily and quickly analysed.

The Air Jet Sieving Machine of the Retsch GmbH is successfully deployed in almost all areas of industry and research within the scope of quality control, especially where there are high demands regarding easy operability, speed, precision and reproducibility.

The AS 200 jet is specially designed for test sieves with an outer diameter from 200 mm and 203 mm (8"). For an optimum measurement result it is recommended to exclusively use test sieves from Retsch GmbH.

**WARNING**

W6.0010

**Handling of food, pharmaceutical and cosmetic products**

Analysed products

- Food, pharmaceutical and cosmetic products, which were analysed with the device must not be consumed, used or circulated.
- **Dispose these substances in accordance with the applicable regulations.**

**NOTICE**

N12.0007

**Range of application of the device**

Long-term operation

- This laboratory device is designed for eight-hour single-shift operation with a duty cycle of 30 %.
- **This device may not be used as a production machine nor is it intended for continuous operation.**

**NOTICE**

N13.0005

**Device damage due to liquids**

Ingress of liquids into the interior of the device

- Mechanical and electronic components are damaged, and the function of the device is no longer ensured.
- **No wet sieving may be carried out with this device!**

## 6.2 Principle of Operation

With the Air Jet Sieving Machine AS 200 jet only one single test sieve is used per sieving process. The test sieve itself does not move during the sieving process. The movement of the sample material on the sieve mesh fabric is achieved by a rotating air jet.

An industrial vacuum cleaner connected to the AS 200 jet generates a negative pressure in the nozzle chamber by sucking ambient air through a silencer. The air jet generated this way exits the rotating slotted nozzle at high speed and disperses the resting sample material from below through the sieve mesh fabric. Above the sieve mesh fabric, the air jet is distributed over the entire surface of the test sieve and is drawn off through the sieve mesh fabric at low speed. The fine fraction of the sample material is transported through the sieve meshes and extracted with the industrial vacuum cleaner. Optionally, the fine fraction can be collected in a cyclone separator.

### 6.3 Views of the Instrument

#### 6.3.1 Front

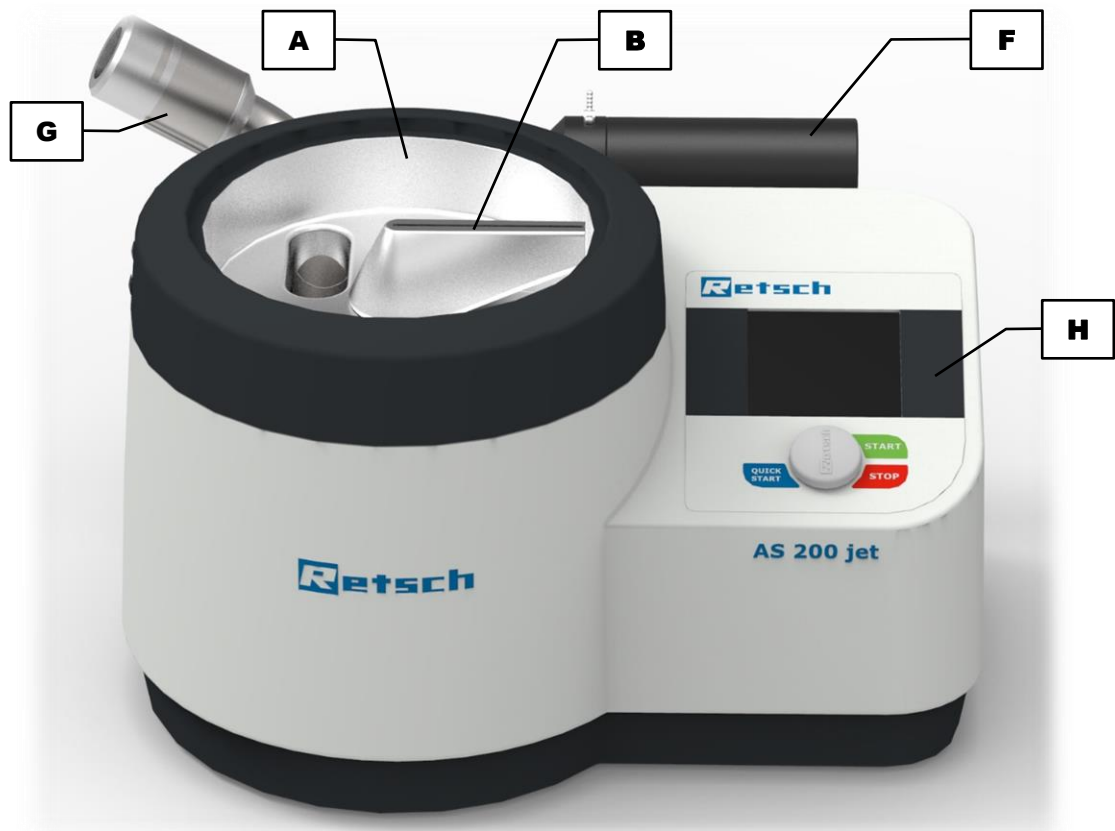

**Fig. 10:** Front view of the device

Element	Description	Function
<b>A</b>	Nozzle chamber	Directs the fine fraction to the air outlet duct (E)
<b>B</b>	Nozzle	Directs the air jet from below through the test sieve (S)
<b>F</b>	Silencer	Reduces the suction noise
<b>G</b>	Manual vacuum regulation	Connection for the external industrial vacuum cleaner, allows for the manual regulation of the negative pressure
<b>H</b>	Control unit with rotary push button	Operation of the device

6.3.2 Back

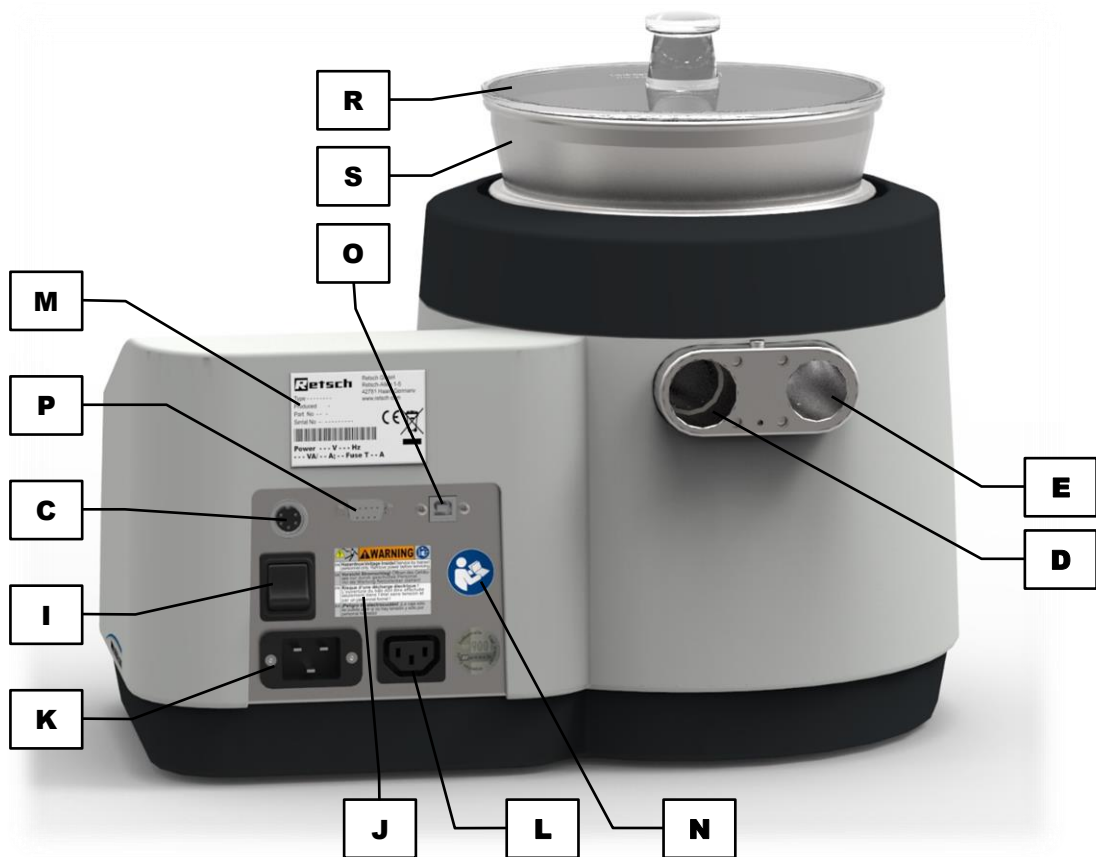

Fig. 11: Back view of the device

Element	Description	Function
<b>C</b>	Device interface (5-pin)	Connection for the automatic vacuum regulation
<b>D</b>	Air inlet duct	Opening for air inlet and connection for the silencer ( <b>F</b> )
<b>E</b>	Air outlet duct	Opening for air outlet and connection for the external suction device
<b>I</b>	Mains switch	Switches the device on and off, disconnects the device from the mains
<b>J</b>	Warning sign "Disconnect from the mains"	Warning of electric shock
<b>K</b>	Mains connection	Connection for the power cable
<b>L</b>	IEC power connection	Connection for the external industrial vacuum cleaner
<b>M</b>	Type plate	Lists, among others, the voltage type, the serial number and the type of the device
<b>N</b>	Sticker "Manual"	Reminds to read the manual
<b>O</b>	USB interface	Data transfer between device and PC, used to communicate with EasySieve®
<b>P</b>	RS232 interface	Data transfer between device and PC, only for service purposes
<b>R</b>	Sieve lid	Cover for the test sieve

<b>s</b>	Test sieve	Contains the sample material for the particle size analysis
----------	------------	---

## 6.4 Switching On / Off

⇒ Turn on the AS 200 jet with the mains switch (I) on the back side of the device.

When the device is switched off, it is completely disconnected from the mains.

## 6.5 Standby Mode

After 15 minutes of inactivity (time without user input and no sieving process in progress), the device automatically switches to standby mode. The display changes to a standby image and displays the current time.



**Fig. 12:** Display in standby mode

⇒ Press one of the buttons (H1), (H2), (H3) or operate the rotary push button (H4). The display returns to the last displayed functions.

**NOTICE** The standby mode cannot be deactivated.

## 6.6 Performing a Sieving

- ⇒ Determine the empty weight of the test sieve.
  - ⇒ Put the sample on the test sieve and weigh it. Make sure not to exceed the [maximum feed quantity](#).
  - ⇒ Place the sieve lid on the test sieve and weigh it (determine the empty weight of the sieve lid).
  - ⇒ Insert the test sieve.
- ⓘ Each test sieve is provided with an O-ring, which serves as a seal to build up the required negative pressure during the sieving.
- ⇒ Set the sieving parameters (→ Chapter "[Controlling the Device](#)").
  - ⇒ Start the sieving process.
  - ⇒ After the end of the sieving process, weigh the test sieve including sieve lid and the particle size fraction present therein.
  - ⇒ Determine the mass of the particle size fraction (weight after the sieving less the empty weight of the test sieve and sieve lid).

- ① The evaluation software "[EasySieve®](#)" automatically records the weights and allows for a quick and simple evaluation of the sieve analysis. A detailed description can be found in the separate manual of the software. Thereby, the communication between the AS 200 jet and the PC is established via a USB cable, which is connected to the USB interface (O).

**NOTICE** The USB interface must be selected in the [basic settings](#).

### 6.6.1 Soft-faced Mallet

To remove deposits of sample material from the bottom side of the sieve lid during the sieving process, the soft-faced mallet included in the delivery can be used.

⇒ Lightly tap on the sieve lid (R) with the soft-face mallet (SH).

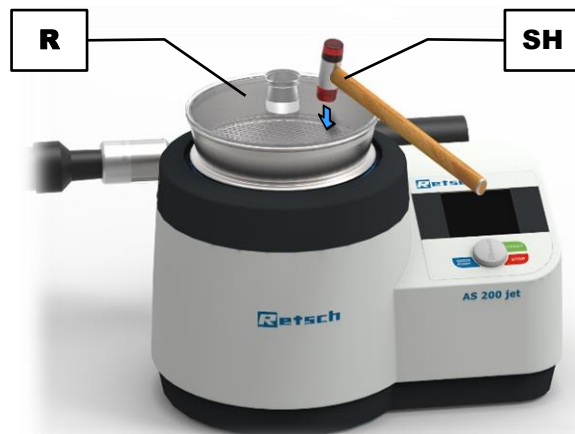

Fig. 13: Using the soft-faced mallet

## 7 Controlling the Device

### 7.1 Operating Controls, Displays and Functions

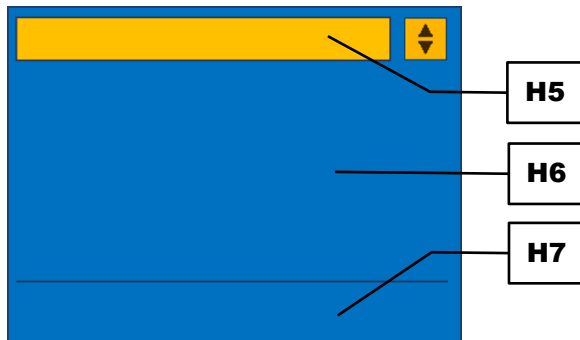

Fig. 14: Control panel areas

Element	Description	Function
<b>H5</b>	Navigation	Selection of the operating modes "Manual", "Programme" and "Quick start", access to the menu "Basic settings"
<b>H6</b>	Settings and display of parameters	Settings of sieving parameters and display of parameters during the sieving process
<b>H7</b>	Device information	Display of the current device settings for "Signal tone", "Interface", "Open mesh" and "Automatic vacuum regulation"



Fig. 15: Control elements and functions

Element	Description	Function
<b>H1</b>	STOP	Stops the sieving process
<b>H2</b>	START	Starts the sieving process with the selected (set) parameters

<b>H3</b>	QUICK START	Starts the sieving process with specified (programmed) parameters
<b>H4</b>	Rotary push button	Allows to enter and select parameters and settings

## 7.2 Operating Modes and Navigation

The device can be operated entirely using the control unit. The operating software can be divided into three operating modes:

- Manual
- Programme
- Quick start

### 7.2.1 Navigation between Operating Modes

- ⇒ Turn the rotary push button (**H4**) until the navigation area (**H5**) is highlighted with a darker background.
- ⇒ Press the rotary push button to activate the navigation area. The navigation icon  (**H5.1**) is now highlighted in yellow.

In the navigation area (**H5**) one of the operating modes "Manual", "Programme 1" to "Programme 9" or "Quick start" can be selected, or the "Basic settings" can be accessed.

- ⇒ Turn the rotary push button until the desired item is displayed.
- ⇒ Press the rotary push button to confirm the selection. The navigation icon  (**H5.1**) is now highlighted in blue.

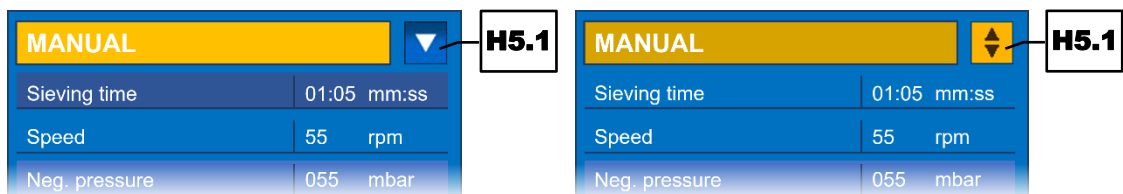

**Fig. 16:** Selection of the operating mode: navigation area not activated (left) and activated (right)

- ⇒ After selection, navigate through the menu items by turning the rotary push button.
- ① If located in a submenu, a fast switch back to the main menu is possible by a prolonged pressing of the rotary push button.

## 7.3 Sieving Parameters

### 7.3.1 Adjustable Parameters

The following parameters can be set via data entry:

- Sieving time
- Speed
- Neg. pressure (only with automatic vacuum regulation)

In manual mode the parameters can be edited directly. In programme mode the parameters can only be changed when the edit mode has been activated via the menu item "Edit program".

- ⇒ Use the rotary push button (**H4**) to navigate to the parameter to be edited. The parameter is highlighted in a darker background.
- ⇒ Press the rotary push button to activate the value edit box. The edit box is highlighted in yellow.
- ⇒ Turn the rotary push button until the desired value is displayed.
- ⇒ Press the rotary push button to save the value. The edit box is no longer highlighted in yellow.

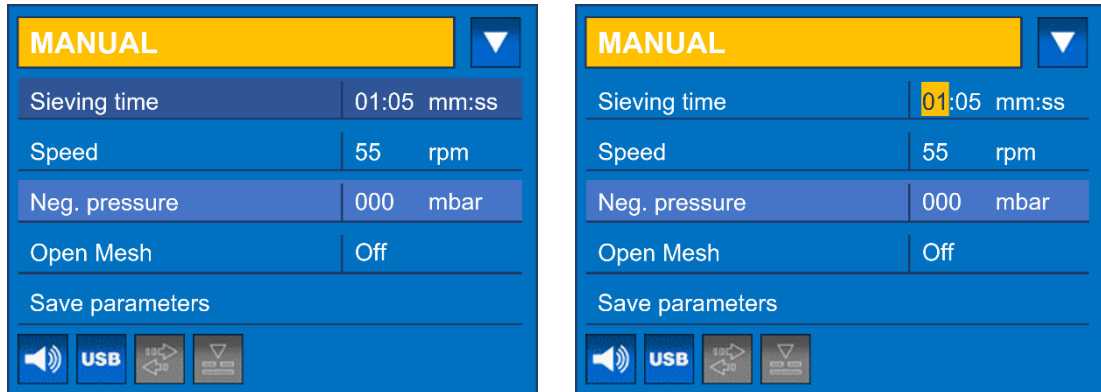

**Fig. 17:** Value input: selection of the parameter "Sieving time" (left), input of the desired value (right)

**Sieving time:**

The sieving time indicates the total duration of the sieving process. An arbitrary sieving time between 00:10 and 99:59 (mm:ss) can be set. The sieving time is continuously counted down to 00:00 after the start of the sieving process.

**Speed:**

The speed (revolutions per minute) can arbitrarily be set between 5 and 55. **NOTICE** With the open mesh function activated, the speed is fixed at 10 rpm.

**Neg. pressure:**

The setting of the negative pressure depends on the configuration of the device:

- When the **manual vacuum regulation (G)** is connected, the negative pressure indicates the actual value during the sieving process, either in Pa, mbar or psi. A setting is not possible. The parameter is highlighted in a somewhat lighter background and cannot be selected.
- When the **automatic vacuum regulation** is connected, the desired negative pressure can be set.

**NOTICE** Make sure that the negative pressure during the sieving process is always less than 100 mbar (10 000 Pa or 1.45 psi).

**7.3.2 Activatable or Deactivatable Parameters**

The following parameters can be activated or deactivated:

- Open Mesh
- Vac cleaner

**Open Mesh:**

The open mesh function of the AS 200 jet has proven to be very helpful in removing very effectively near-mesh particles from the sieve mesh fabric. This function causes the nozzle (**B**) to move unsteady underneath the test sieve. According to the principle of "two steps forward,

one backward", the nozzle first moves forward for 20° to subsequently perform a backward movement of 10°. As a result, near-mesh particles can be better removed because no resting sample material obstructs the air flow.

With the function activated, the speed is fixed to 10 rpm. The current setting is displayed by one of the following icons:



Open mesh function activated





Open mesh function deactivated

The open mesh function can be edited directly in manual mode. In programme mode the parameter can only be changed when the edit mode has been activated via the menu item "Edit program".

- ⇒ Use the rotary push button (**H4**) to navigate to the parameter "Open Mesh". The parameter is highlighted in a darker background.
- ⇒ Press the rotary push button to activate the edit box. The edit box is highlighted in yellow.
- ⇒ Turn the rotary push button until the function is "On" or "Off" as desired.
- ⇒ Press the rotary push button to save the input. The edit box is no longer highlighted in yellow.

#### Vac cleaner:

In manual mode, the external industrial vacuum cleaner can be switched on manually via the menu item "Vac cleaner" and thus also used to clean the device. The vacuum cleaner function is only available in manual mode.

- ⇒ Disconnect the suction pipe (**SR**) from the air outlet duct (**E**) or from the manual (**G**) or automatic vacuum regulation.
- ⇒ Use the rotary push button (**H4**) to navigate to the parameter "Vac cleaner". The parameter is highlighted in a darker background.
- ⇒ Press the  button (**H2**). The external industrial vacuum cleaner is switched on.
- ⇒ To switch off the external industrial vacuum cleaner, press the  button (**H1**).

## 7.4 Manual Mode

In manual mode, the following parameters can be edited directly:

- Sieving time
- Speed
- Neg. pressure (only with automatic vacuum regulation)
- Open mesh
- Vac cleaner

Some settings can also be modified during the sieving process. A detailed description of the parameter settings can be found in Chapter "[Sieving Parameters](#)".

#### Save parameters:

The parameters set in manual mode can be assigned to an arbitrary programme memory position or the  button (**H3**) via the "Save parameters" function.

- ⇒ In manual mode, navigate to the menu item "Save parameters" (**H6.1**).
- ⇒ Press the rotary push button (**H4**) to confirm the selection and to enter the submenu "SAVE PARAMETERS".

- ⇒ Select the desired programme memory position under the item "Program".
- ⇒ Select "Save" to overwrite the selected programme memory position with the current parameters.
- ⇒ To cancel the process, select "Back".

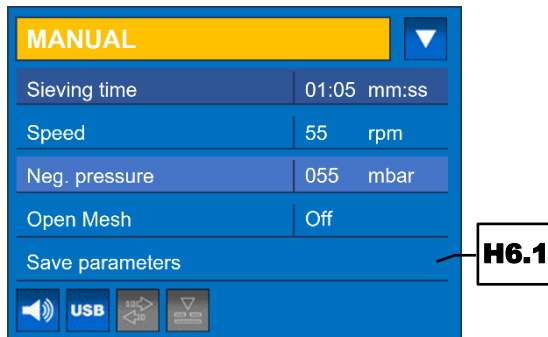



Fig. 18: Manual mode

### 7.4.1 Start Process

- ⇒ Press the  button (H2) to start the sieving process.

During the manual sieving process, the sieving time and/or the speed can be modified. If an automatic vacuum regulation is connected, the negative pressure can also be changed during operation. All other parameters cannot be changed during operation.



**NOTICE** Without the sieve lid (R) on, no negative pressure can be built up and thus no sieving process can be carried out.

### 7.4.2 Stop Process



The sieving process will stop automatically after the set sieving time has elapsed. However, the sieving process can be stopped manually at any time.

- ⇒ Press the  button (H1) to stop the sieving process.

## 7.5 Quick Start

In the "Quick start" operating mode, a frequently used parameter set can be defined and assigned to the  button (H3). A sieving process can thus be started easily and at any time with the preferred parameters via the  button (H3).

### Assign parameters to the button:

- ⇒ Navigate to the operating mode "QUICK START" (→ Chapter "[Navigation between Operating Modes](#)"). The currently set parameters are displayed.
- ⇒ Navigate to the menu item "Edit program".
- ⇒ Press the rotary push button to enter the submenu "EDIT PROGRAM".
- ⇒ Define the desired parameters for the  button (→ Chapter "[Adjustable Parameters](#)" and "[Activatable or Deactivatable Parameters](#)").
- ⇒ Select "Save" to assign the changes to the  button.
- ⇒ To discard the changes, select "Back".

Start the sieving process via the  button:

- ⇒ Press the  button (H3) to start the sieving process with the parameters specified under the operating mode "QUICK START".

## 7.6 Programme Mode

Often different but perseverative sample materials with individual sieving parameters are being processed. For such samples, individual parameter sets can be saved in programmes and retrieved when needed.

There are nine programme memory positions available. The following sieving parameters can be stored in the individual programmes:

- Sieving time
- Speed
- Neg. pressure (only with automatic vacuum regulation)
- Open Mesh

Please refer to Chapter "[Sieving Parameters](#)" for a detailed description of the parameter settings.

### 7.6.1 Select a Programme

- ⇒ Turn the rotary push button (H4) until the navigation area (H5) is highlighted with a darker background.
- ⇒ Press the rotary push button to activate the navigation area.
- ⇒ Turn the rotary push button until the desired programme is displayed.
- ⇒ Press the rotary push button to confirm the selection.
- ⇒ Press the  button (H2) to start the sieving process in programme mode.

### 7.6.2 Edit a Programme

- ⇒ In programme mode, navigate to the menu item "Edit program" (H6.2).
  - ⇒ Press the rotary push button to confirm the selection and to enter the submenu "EDIT PROGRAM" (H5.2).
- ① In the submenu "EDIT PROGRAM", the parameters of the active or any other programme memory position including the "Quick start" mode can be edited.
- ① The submenu "EDIT PROGRAM" is also accessible in "Quick start" mode.

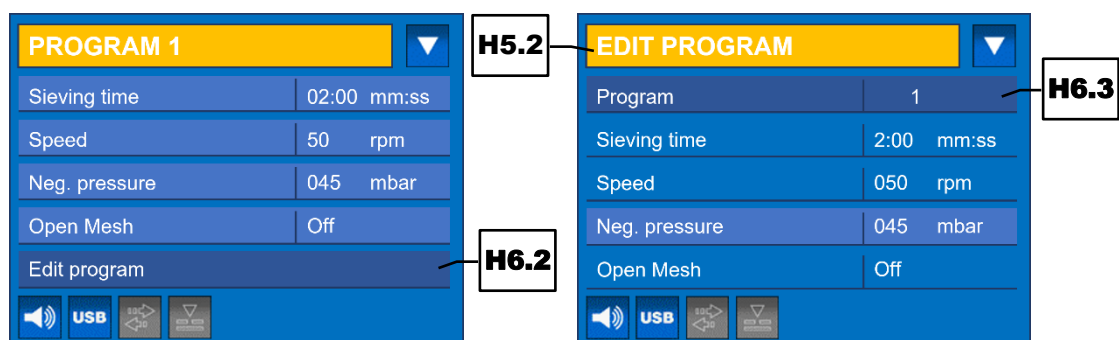

Fig. 19: Edit programme: programme mode (left) and submenu "EDIT PROGRAM" (right)

- ⇒ Select the desired programme memory position under the item "Program" (**H6.3**).
- ⇒ Define the desired parameters (→ Chapter "[Adjustable Parameters](#)" and "[Activatable or Deactivatable Parameters](#)").

### 7.6.3 Save a Programme

- ⇒ Select "Save" to overwrite the selected programme memory position with the set parameters.
- ⇒ To cancel the process, select "Back".

### 7.6.4 Delete a Programme

- ⇒ In programme mode, navigate to the menu item "Delete program".
- ⇒ Press the rotary push button to confirm the selection and to enter the submenu "DELETE PROGRAM".
- ① In the submenu "DELETE PROGRAM", the parameters of the active or any other programme memory position can be deleted. The parameters of the operating mode "Quick start" cannot be deleted.

**NOTICE** Although, in "Quick start" mode, the submenu "DELETE PROGRAM" is displayed in grey, it is not accessible.

- ⇒ Select the desired programme memory position under the item "Program".
- ⇒ Select "Delete" to delete the sieving parameters in the selected programme memory position.
- ⇒ To cancel the process, select "Back".

After clearing the settings, the sieving time, the speed and the negative pressure of this programme memory position are set to zero and the open mesh function is deactivated.

## 7.7 Basic Settings

The following menu items can be accessed in the basic settings:

- Neg. pressure
- Languages
- Brightness
- Date
- Time
- Signal tone
- Interface
- Service

The individual functions are described in detail in the following subchapters.

### 7.7.1 Negative Pressure

The negative pressure can be displayed either in Pascal (Pa), millibar (mbar) or pound-force per square inch (psi).

- ⇒ Use the rotary push button (**H4**) to navigate to the menu item "Neg. pressure". The parameter is highlighted in a darker background.



- ⇒ Press the rotary push button to activate the edit box. The edit box is highlighted in yellow.
- ⇒ Turn the rotary push button until the desired unit is displayed.
- ⇒ Press the rotary push button to save the input. The edit box is no longer highlighted in yellow.

### 7.7.2 Languages

Under this menu item, the language of the control panel can be selected.

- ⇒ Use the rotary push button (**H4**) to navigate to the menu item "Languages". The parameter is highlighted in a darker background.
- ⇒ Press the rotary push button to enter the submenu "LANGUAGES".
- ⇒ Turn the rotary push button until the desired language is highlighted in a darker background.
- ⇒ Press the rotary push button to confirm the language selection. After the selection, the entire menu structure is displayed in the selected language.

**NOTICE** If a wrong language has been accidentally set, the submenu "LANGUAGES" can be accessed directly with the following steps:

- ⇒ Turn off the device.
- ⇒ Simultaneously press the  (**H1**), , and  (**H3**) buttons while turning the device back on via the mains switch (**I**). The submenu "LANGUAGES" is displayed.
- ⇒ Select the desired language.

### 7.7.3 Brightness

The brightness of the display can be set arbitrarily between 0 % and 100 % and thus adjusted to the environment (e.g. solar radiation, light conditions).

- ⇒ Use the rotary push button (**H4**) to navigate to the menu item "Brightness". The parameter is highlighted in a darker background.
- ⇒ Press the rotary push button to activate the edit box. The edit box is highlighted in yellow.
- ⇒ Turn the rotary push button until the desired value is displayed, i.e. the desired brightness is set.
- ⇒ Press the rotary push button to save the input. The edit box is no longer highlighted in yellow.

### 7.7.4 Date

Via the menu item "Date" the current date can be set. The device can be disconnected from the mains for up to 30 days without losing the settings.

- ⇒ Use the rotary push button (**H4**) to navigate to the menu item "Date". The parameter is highlighted in a darker background. The date is displayed in the format year-month-day (yyyy-mm-dd) in three separate edit boxes.
- ⇒ Press the rotary push button to activate the first edit box (year). The edit box is highlighted in yellow.
- ⇒ Turn the rotary push button until the current year is set and confirm the input by pressing the rotary push button. The next edit box is activated.
- ⇒ Set the current month and confirm the input by pressing the rotary push button. The last edit box is activated.
- ⇒ Set the current day. Press the rotary push button to save the input. The edit box is no longer highlighted in yellow.

### 7.7.5 Time

Via the menu item "Time" the current time can be set. The device can be disconnected from the mains for up to 30 days without losing the settings.

- ⇒ Use the rotary push button (**H4**) to navigate to the menu item "Time". The parameter is highlighted in a darker background. The date is displayed in the format hour:minute:second (hh:mm:ss) in three separate edit boxes.
- ⇒ Press the rotary push button to activate the first edit box (hour). The edit box is highlighted in yellow.
- ⇒ Turn the rotary push button until the current hour is set in the 24-hour clock and confirm the input by pressing the rotary push button. The next edit box is activated.
- ⇒ Set the current minute and confirm the input by pressing the rotary push button. The last edit box is activated.
- ⇒ Set the current second. Press the rotary push button to save the input. The edit box is no longer highlighted in yellow.

### 7.7.6 Signal Tone

The end of the sieving process, as well as occurring error messages can be signalled acoustically by a warning tone.

- ⇒ Use the rotary push button (**H4**) to navigate to the menu item "Signal tone". The parameter is highlighted in a darker background.
- ⇒ Press the rotary push button to activate the edit box. The edit box is highlighted in yellow.
- ⇒ Turn the rotary push button until the function is "On" or "Off" as desired.
- ⇒ Press the rotary push button to save the input. The edit box is no longer highlighted in yellow.

The current setting is displayed by one of the following icons:



Signal tone activated



Signal tone deactivated

### 7.7.7 Interface

Under this menu item, the interface for the data transfer between the AS 200 jet and a PC can be selected. It is possible to switch between the RS232 (**P**) and USB interface (**O**).

- ⇒ Use the rotary push button (**H4**) to navigate to the menu item "Interface". The parameter is highlighted in a darker background.
- ⇒ Press the rotary push button to activate the edit box. The edit box is highlighted in yellow.
- ⇒ Turn the rotary push button until "RS232" or "USB" is displayed as desired.
- ⇒ Press the rotary push button to save the input. The edit box is no longer highlighted in yellow.

The current setting is displayed by one of the following icons:



RS232 interface activated



USB interface activated

The RS232 interface serves as access for service work and is only intended for service technicians from Retsch GmbH.

The USB interface is used for data transfer between the AS 200 jet and a PC. **NOTICE** For the communication with the evaluation software [EasySieve®](#) available as an accessory, the USB interface must be activated.

### 7.7.8 Service

Under this menu item, the service environment can be accessed.

- ⇒ Use the rotary push button (**H4**) to navigate to the menu item "Service". The parameter is highlighted in a darker background.
- ⇒ Press the rotary push button to enter the submenu "SERVICE".

The submenu "SERVICE" provides access to the following device information and functions:

Submenu item	Description
Total operation hours	Displays the operating hours of the device in hours and minutes (h:m). The process times, i.e. the times between start and stop are counted. The time cannot be manipulated.
Display software version	Displays the version number of the display software (programme control).
Controller software version	Displays the version number of the firmware (device control).
Serial number	Displays the serial number of the device.
Calibration until	<p>Displays the date until which the device is calibrated. The reminder date is displayed in the format year-month-day (yyyy-mm-dd) and can be set via the rotary push button (<b>H4</b>). If the date is exceeded, the  icon (<b>H7.1</b>) is displayed.</p> <p><b>NOTICE</b> A correctly set reminder date is important for the adherence of the calibration intervals. Especially, when the device is used in quality control and thus must be regularly calibrated in accordance with DIN EN ISO 9000 ff.</p>
Update software	Via this menu item, the display software and/or the firmware can be updated. <b>NOTICE</b> An update is only possible via a PC connected to the RS232 interface and the corresponding programming software.
Calibration sensor	Via this menu item, the pressure sensor of the AS 200 jet can be calibrated (→ Chapter " <a href="#">Calibration of the Pressure Sensor</a> ").
Service level	The service level can only be accessed by service technicians from Retsch GmbH.
Back	Via this menu item the submenu "SERVICE" can be left again.

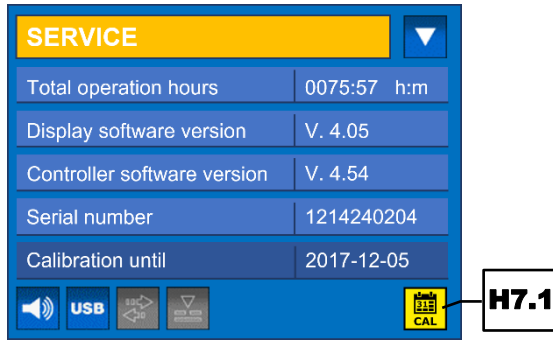
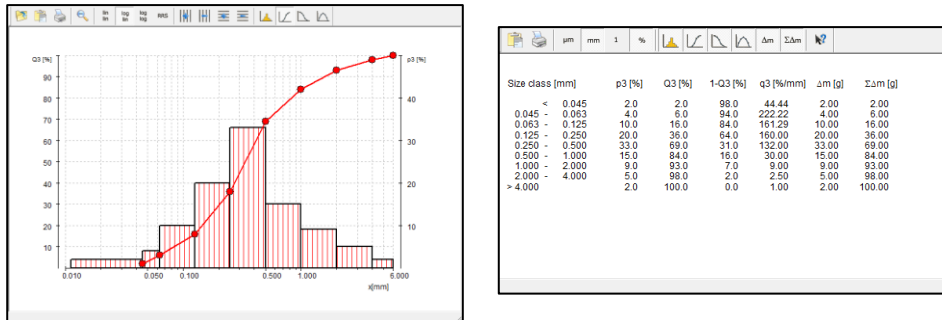

**Fig. 20:** Submenu "SERVICE"

## 8 EasySieve®

EasySieve® is a software for particle size analysis and simplifies the manual evaluation in many respects. The software is able to automatically perform the required measuring and weighing processes – from determining the weights of the test sieves to evaluating the data.

The software is structured in a self-explanatory way and follows the logical chain of events involved in a particle size analysis. Therefore, the training period will be very short. The abundance of evaluation options provides absolute flexibility in adapting to demanding, individual tasks.



**Fig. 21:** Graphic and tabular presentation of the particle size analysis with EasySieve®

The software communicates with the scale and the AS 200 jet and guides the user through the respective steps. Available parameters, as well as the characteristics to be calculated can be entered in various edit boxes. Routine parameters can be edited, saved and recalled at any time.

If a scale is connected, the corresponding data (empty weights of test sieves, back weights of loaded test sieves) can be transferred directly to EasySieve®. If no scale is connected, the input can also be entered manually.

The software calculates all standard particle distributions, as well as the representative characteristics of the particle size, and allows for the tabular and graphical presentation of results in a measurement report conforming to standards. Furthermore, the data can be exported to other software products (e.g. Microsoft Excel).

EasySieve® is also available as AuditTrail enabled version in compliance with 21CFR Part 11.

① A detailed description can be found in the separate manual of the software.

## 9 Error Messages and Information Notes

### 9.1 Error Messages

Error messages inform the user about detected device or programme errors. In the event of an error message, a fault has occurred, in which the operation of the device or the programme is automatically interrupted. Such faults must be resolved before next startup.

Error code	Description	Measures
<b>E11</b>	Failure drive / motor	<ul style="list-style-type: none"> <li>⇒ Switch off the main switch and wait for 30 s before switching on again.</li> <li>⇒ If the error persists, contact service.</li> </ul>
<b>E24</b>	Failure valve	<ul style="list-style-type: none"> <li>⇒ Confirm the message on the control panel.</li> <li>⇒ Check the connection (control cable and plugs) of the automatic vacuum regulation to the AS 200 jet.</li> <li>⇒ If the error persists, contact service.</li> </ul>
<b>E25</b>	Failure main board	<ul style="list-style-type: none"> <li>⇒ Switch off the main switch and wait for 30 s before switching on again.</li> <li>⇒ If the error persists, contact service.</li> </ul>
<b>E83</b>	Negative pressure too low	<ul style="list-style-type: none"> <li>⇒ Confirm the message on the control panel.</li> <li>⇒ Check whether the industrial vacuum cleaner is correctly connected and generates sufficient negative pressure.</li> <li>⇒ Check if the vacuum cleaner bag is full.</li> <li>⇒ Check that the sieve lid is correctly positioned on the test sieve.</li> <li>⇒ If the error persists, contact service.</li> </ul>
<b>E84</b>	Negative pressure drop	<ul style="list-style-type: none"> <li>⇒ Confirm the message on the control panel.</li> <li>⇒ Check whether the industrial vacuum cleaner is correctly connected and generates sufficient negative pressure.</li> <li>⇒ Check if the vacuum cleaner bag is full.</li> <li>⇒ Check that the sieve lid is correctly positioned on the test sieve.</li> <li>⇒ If the error persists, contact service.</li> </ul>

### 9.2 Information Notes

Notices inform the user on specific device or programme processes. The operation of the device or programme may be interrupted briefly, but there is no fault. The information notice must be acknowledged by the user to continue the process. Information notices provide additional information for the user as an aid, but do not represent any device or programme errors.

Notice code	Description	Measures
<b>H45</b>	Mains interruption	⇒ Confirm the message on the control panel.

## 10 Return for Service and Maintenance



**Fig. 22:** Return form

The acceptance of devices and accessories of the Retsch GmbH for repair, maintenance or calibration can only be effected, if the return form including the decontamination declaration service has been correctly and fully completed.

- ⇒ Download the return form located in the download section "Miscellaneous" on the Retsch GmbH homepage (<http://www.retsch.com/downloads/miscellaneous/>).
- ⇒ When returning a device, attach the return form to the outside of the packaging.

In order to eliminate any health risk to the service technicians, Retsch GmbH reserves the right to refuse the acceptance and to return the respective delivery at the expense of the sender.

## 11 Cleaning, Wear and Maintenance

### 11.1 Cleaning

**⚠ WARNING**

W7.0003

**Danger to life through electric shock**  
Cleaning with water

- An electric shock can cause burns, cardiac arrhythmia, respiratory arrest, as well as cardiac arrest.
- **The power cable must be unplugged before cleaning the device.**
- **Use a cloth dampened with water for cleaning.**
- **Do not clean the device under running water!**



**NOTICE**

N14.0009

**Damage to the housing and device**  
Use of organic solvents

- Organic solvents may damage plastic parts and the coating.
- **The use of organic solvents is not permitted.**

- ⇒ Clean the housing of the device with a damp cloth and if necessary, with a household cleaning agent. Pay attention that no water or cleaning agent enters the interior of the device.
- ⇒ Clean the nozzle chamber (**A**) and the air outlet duct (**E**) with a paint brush and vacuum the loosened material residues with the industrial vacuum cleaner. To do so, the industrial vacuum cleaner can be switched on separately via the control unit (→ Chapter "[Activatable or Deactivatable Parameters](#)").
- ⇒ Alternatively, the nozzle chamber can also be cleaned with compressed air.
- ⇒ If necessary, exchange the vacuum cleaner bag or empty the collecting container of the industrial vacuum cleaner.
- ⇒ Check the degree of contamination of the vacuum cleaner filters at regular intervals and replace them if necessary.

**⚠ CAUTION**

C12.0031

**Risk of injury**  
Cleaning with compressed air

- When using compressed air for cleaning purposes dust and remnant of the sample material can be flung around and injure eyes.
- **Always wear safety glasses when cleaning with compressed air.**
- **Observe the material safety data sheets of the sample material.**



#### 11.1.1 Cleaning of Test Sieves

Test sieves are measuring instruments and should be treated with due care before, during and after the sieving process. It is recommended to clean new test sieves before the first use from possible preservative residues with ethanol or isopropanol and to store them in a dry, dust-free place when unused.

Before cleaning or drying the test sieves, the O-rings have to be removed. Before using and after the cleaning the test sieves should be visibly inspected for possible damages and impurities.

Near-mesh or clamped particles can be often removed dry after the sieving process by slightly tapping the test sieve upside down with the sieve frame on a table. For test sieves with mesh sizes > 500 µm a fine hair brush can be used to sweep over the outer side of the mesh fabric.

#### 11.1.1.1 Cleaning of Test Sieves with Mesh Sizes > 500 µm

Coarse mesh fabrics with mesh sizes > 500 µm can be cleaned dry or wet easily and effectively with a hand brush with plastic bristles (at not too high applied pressure).

#### 11.1.1.2 Cleaning of Test Sieves with Mesh Sizes < 500 µm

Test sieves with mesh sizes < 500 µm should generally only be cleaned in an ultrasonic cleaning-bath. As cleaning agent, water together with a standard surfactant is recommended. The cleaning in the ultrasonic bath usually takes two to three minutes. After that the test sieves are thoroughly rinsed with water and dried. The cleaning with strong bases or acids is generally not recommended.

#### 11.1.1.3 Drying of Test Sieves

Drying ovens of various sizes can be used for drying test sieves (drying temperature < 80 °C).

Additional information concerning ultrasonic cleaning-baths and drying ovens can be found on the Retsch GmbH homepage (<http://www.retsch.com>). Also ask for the free expert guide *Sieve Analysis – Taking a close look at quality*.

### NOTICE

N15.0028

#### **Damage of the sieve mesh fabric**

Drying temperature > 80 °C

- At higher temperatures, especially fine metal wire meshes can become warped, leading to a reduced tension of the mesh fabric inside the sieve frame and hence, makes the test sieve less efficient during the sieving process.
- **The drying temperature for test sieves must not exceed 80 °C!**

## 11.2 Wear

Even with the proper handling of the test sieves, a wearing of the sieve mesh fabric depending on the frequency of the sieving operation and on the sample material is unavoidable. The test sieves should be regularly checked for wear and damage and be replaced if necessary.

Likewise, all existing sealing gaskets should be checked for wear on a regular basis and replaced if necessary.

**CAUTION**

C13.0013

**Personal injury**  
Improper repairs

- This manual does not contain any repair instructions.
- **For safety reasons, repairs may only be carried out by Retsch GmbH or an authorised representative or by qualified service technicians.**

### 11.3 Maintenance

The AS 200 jet is largely maintenance-free.

It is possible to calibrate the pressure sensor (→ Chapter "[Calibration of the Pressure Sensor](#)"). This is especially important, when the device is used in quality control and thus must be regularly calibrated in accordance with DIN EN ISO 9000 ff.

### 11.4 Calibration of the Pressure Sensor

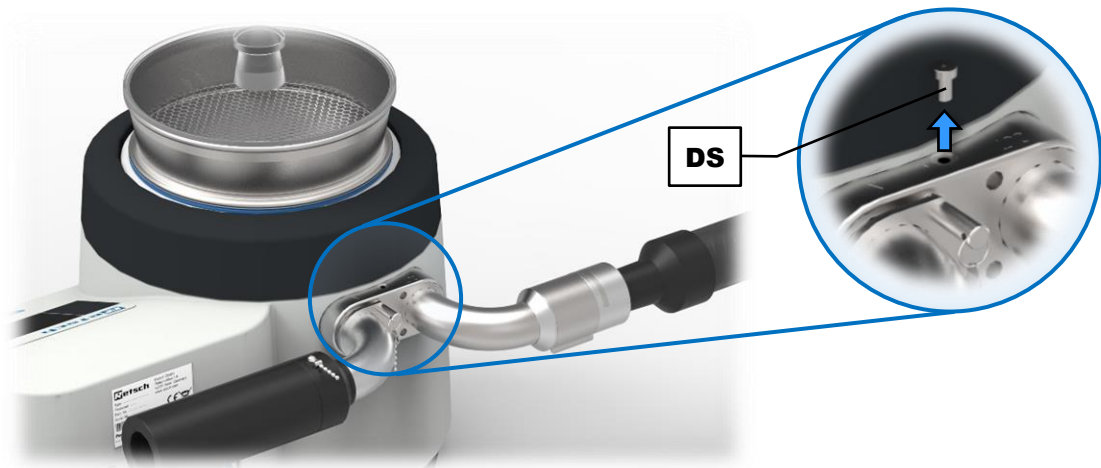

**Fig. 23:** Sealing screw

- ⇒ Remove the sealing screw (**DS**).
- ⇒ Insert a test sieve with a suitable sieve lid.
- ⇒ Connect an industrial vacuum cleaner to the manual vacuum regulation.



**Fig. 24:** Connecting a manometer

- ⇒ Connect a suitable differential pressure manometer (e.g. PCE-P05) to the measuring port **(MO)**.
- ⇒ Use the rotary push button **(H4)** to navigate to the menu item "Service". The parameter is highlighted in a darker background.
- ⇒ Press the rotary push button to enter the submenu "SERVICE".
- ⇒ Use the rotary push button to navigate to the menu item "Calibration sensor". The parameter is highlighted in a darker background.
- ⇒ Press the rotary push button to enter the submenu "CALIBRATION SENSOR".
- ⇒ Press the **START** button **(H2)**.

The AS 200 jet now automatically switches on the industrial vacuum cleaner. However, the nozzle does not rotate. The negative pressure (differential pressure) is displayed in the menu item "Neg. pressure".

- ⇒ Compare the displayed negative pressure on the control unit of the AS 200 jet with the measured value of the connected differential pressure manometer.
- ⇒ If desired, change the setting of the manual vacuum regulation to check additional measuring points.
- ⇒ Press the **STOP** button **(H1)** to end the calibration.
- ⇒ Remove the differential pressure manometer and screw the sealing screw **(DS)** back in.

## 12 Accessories

Information on available accessories as well as the respective manuals are accessible directly on the Retsch GmbH homepage (<http://www.retsch.com>) under the heading "Downloads" of the device.

Information on wear parts and small accessories can be found in the Retsch GmbH general catalogue also available on the homepage.

In case of any questions concerning spare parts please contact the Retsch GmbH representative in your country, or Retsch GmbH directly.

### 12.1 Automatic Vacuum Regulation

As an accessory available from Retsch GmbH, the automatic vacuum regulation allows for the automatic control of the airflow strength on the Air Jet Sieving Machine AS 200 jet in the control range  $\Delta p$  of 50 mbar.

The AS 200 jet measures the current negative pressure in the nozzle chamber (**A**) and accordingly controls the automatic vacuum regulation. As a result, fluctuations caused by the industrial vacuum cleaner are compensated and thus the negative pressure kept stable.

### 12.2 Connecting the Automatic Vacuum Regulator

#### CAUTION

##### Hearing damage

Due to suction noises at the suction opening a high sound level may be generated

- Excessive noise in terms of level and duration can cause impairments or permanent damage to hearing.
- **Ensure suitable noise protection measures are taken or wear ear protection.**

C14.0046



#### CAUTION

##### Danger of objects being ejected

Connection of compressed air instead of an industrial vacuum cleaner

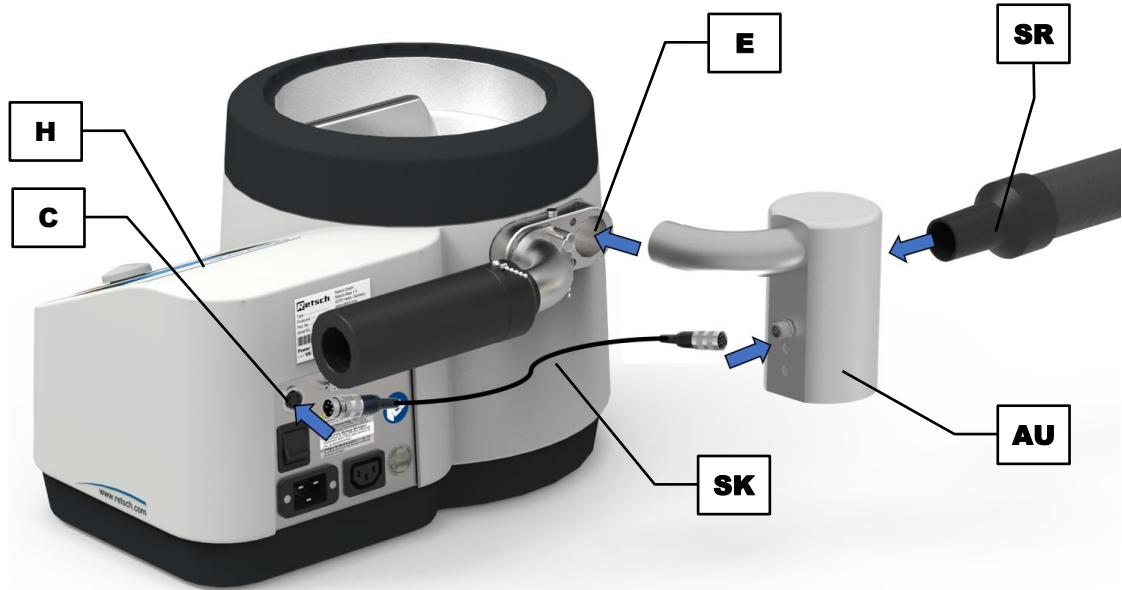

- If compressed air is connected to one of the two air ducts, the sieve lid and the test sieve will be ejected.
- **The device may not be operated with compressed air!**

C15.0049



**Fig. 25:** Installation of the automatic vacuum regulation

- ⇒ Insert the automatic vacuum regulation (**AU**) into the air outlet duct (**E**).
- ⇒ Connect the 5-pin control cable (**SK**) to the device interface (**C**) for the automatic vacuum regulation.
- ⇒ Connect the suction pipe (**SR**) of the industrial vacuum cleaner to the automatic vacuum regulation (**AU**).

If the control cable of the automatic vacuum regulation is connected to the AS 200 jet, it is automatically detected and the  icon is displayed in the control unit (**H**). If no automatic vacuum regulation is connected, the  icon is displayed in grey.

### 12.3 Adjustment of the Automatic Vacuum Regulation



**Fig. 26:** Automatic vacuum regulation

When the automatic vacuum regulation is connected, the desired negative pressure can be set between 20 and 100 mbar. The automatic vacuum regulation can keep the negative pressure stable in a control range  $\Delta p$  of 50 mbar.

**NOTICE** Make sure that the negative pressure during the sieving process is always less than 100 mbar (10 000 Pa or 1.45 psi).

### 12.4 Cyclone Separator

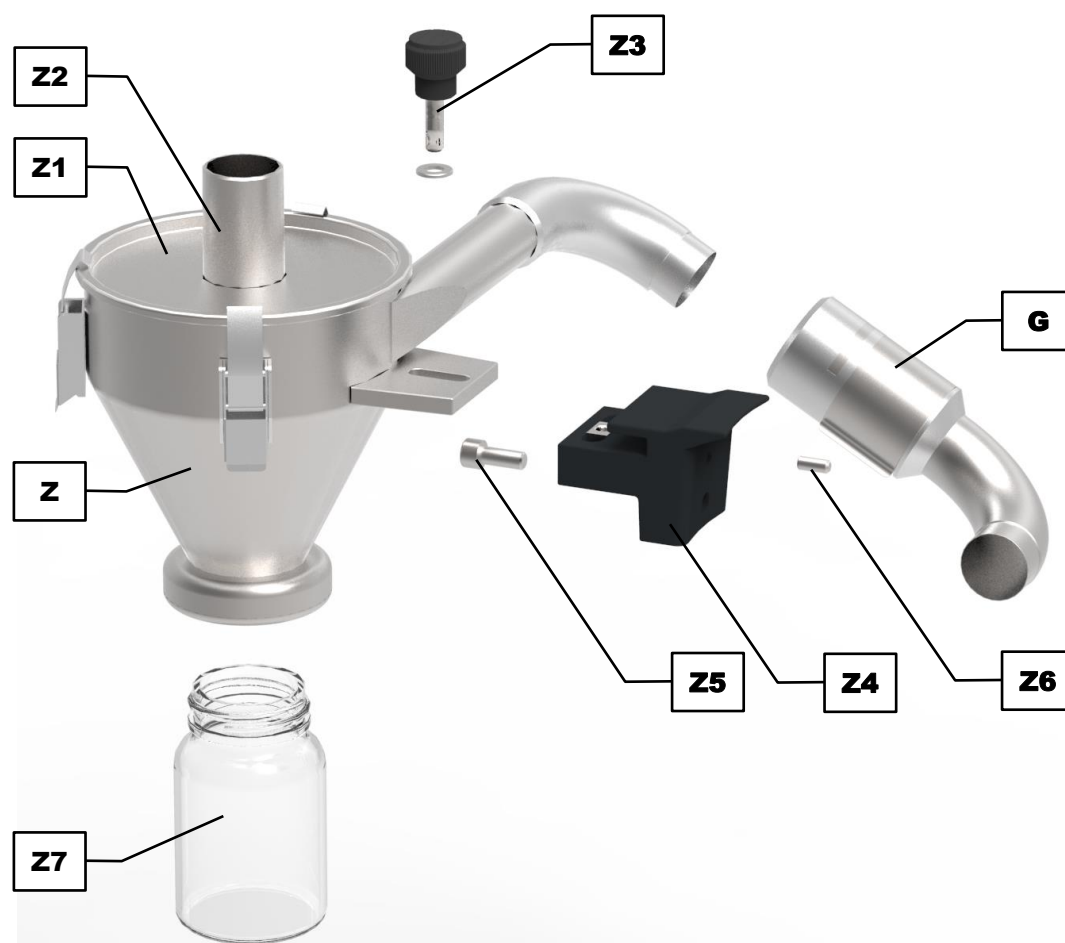
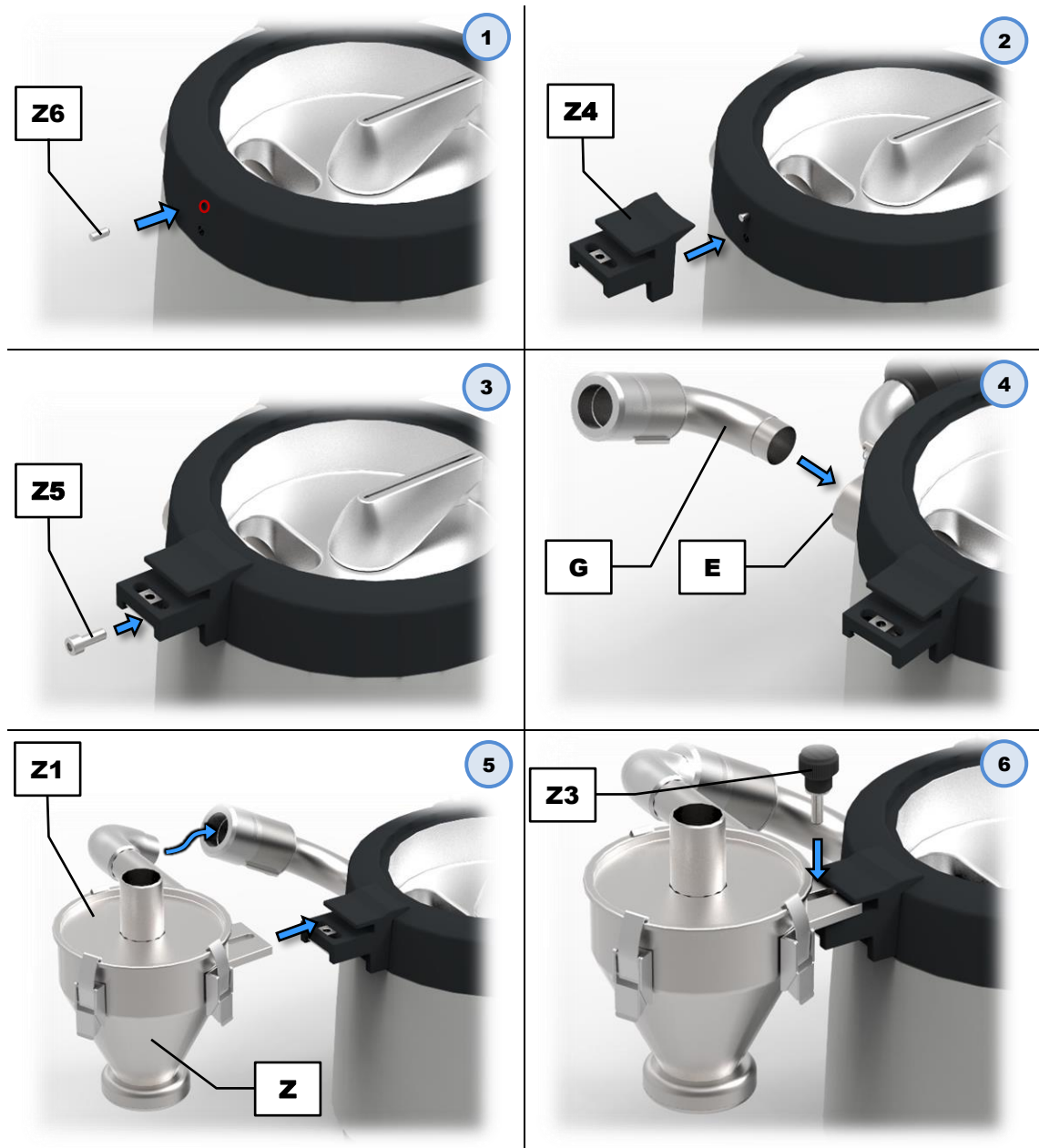

Fig. 27: Individual parts of the cyclone separator

Element	Description	Function
<b>G</b>	Manual vacuum regulation	Allows for the manual regulation of the negative pressure
<b>Z</b>	Cyclone separator	Separates the undersize (sifted sample material) from the airflow
<b>Z1</b>	Cyclone lid	Removable lid with air outlet (Z2)
<b>Z2</b>	Air outlet	Connection for the industrial vacuum cleaner
<b>Z3</b>	Knurled head screw with washer	Secures the cyclone separator (Z) to the bracket (Z4)
<b>Z4</b>	Bracket of the cyclone separator	Adapter between the cyclone separator (Z) and the AS 200 jet
<b>Z5</b>	Fixing screw	Fixes the bracket (Z4) to the housing of the AS 200 jet
<b>Z6</b>	Cylinder pin	Serves as an anti-rotation lock for the bracket (Z4)
<b>Z7</b>	Receptacle	Collecting vessel for the undersize

### 12.4.1 Connecting the Cyclone Separator



**Fig. 28:** Mounting the cyclone separator

- ⇒ Insert the cylinder pin (**Z6**) in the top of the two housing openings. If necessary, remove the two plastic covers from the openings in the housing.
- ⇒ Place the bracket (**Z4**) on the cylinder pin (**Z6**).
- ⇒ Screw the bracket (**Z4**) to the housing of the AS 200 jet by means of fixing screw (**Z5**).
- ⇒ Connect the [manual vacuum regulation](#) (**G**) to the air outlet duct (**E**). Alternatively, the [automatic vacuum regulation](#) can be mounted.
- ⇒ Insert the cyclone separator (**Z**) with attached cyclone lid (**Z1**) into the mounted vacuum regulation and position the cyclone separator so that the mounting plate on the cyclone separator fits into the bracket (**Z4**) on the housing of the AS 200 jet.
- ⇒ Screw the cyclone separator (**Z**) into the bracket (**Z4**) by means of the knurled head screw (**Z3**).



**Fig. 29:** Connecting the industrial vacuum cleaner to the mounted cyclone separator

- ⇒ Plug the suction pipe (SR) of the industrial vacuum cleaner onto the air outlet (Z2) in the cyclone lid (Z1).
- ⇒ Screw the receptacle (Z7) from below to the cyclone separator (Z).

Grounding the device via the protective earth of the mains connection prevents electrostatic charges inside the device. **⚠ CAUTION** Therefore, always pay attention to the correct installation of the cyclone separator to ensure adequate grounding!

**NOTICE** Depending on the properties of the sample material, the flow velocity and the humidity, an electrostatic charge can still occur inside the receptacle due to charge separation between the sample material and the wall of the vessel.

## 12.5 Test Sieves

Decisive for the accuracy and reliability of the measurement result is, in addition to the reproducible operating Air Jet Sieving Machine the quality of the test sieve. Test sieves of Retsch GmbH are high quality measuring instruments for which only mesh fabrics and perforated sheets of the corresponding standards are used. Each test sieve is tested five times and is given a serial number, as well as a quality certificate after the final check.

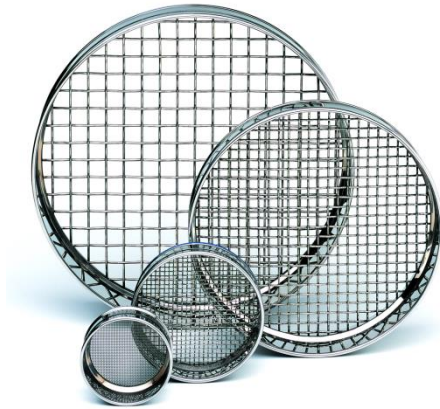

**Fig. 30:** Test sieves

The different versions of the test sieves of Retsch GmbH are supplied in accordance with all current national and international standards:

- available standards: DIN, ISO, ASTM, BS, NF, CGSB
- available diameters: 100 mm / 150 mm / 200 mm / 203 mm (8") / 305 mm (12") / 400 mm / 450 mm (18")
- available sieve surfaces: sieve mesh fabric (20 µm to 125 mm) and perforated screens (round, elongated or square holes) of stainless steel
- on request with an individual test certificate for the inspection of measuring and testing equipment monitoring according to ISO 9000 ff.

Among the various test sieves matching collecting pans, collecting pans with outlet, intermediate pans, intermediate rings, venting rings and sieve lids are available.

### 12.5.1 Certificate

Before delivery, each test sieve is optically surveyed according to the standards DIN ISO 3310-1 and ASTM E 11, and provided a certificate of compliance with the order.

On request, an additional acceptance test certificate with a calibration protocol can be provided, documenting the measurement results in tabular and graphical form, hence representing a calibration certificate with more detailed statistics.

### 12.5.2 Calibration Service

As a special service Retsch GmbH offers the calibration of the test sieves. All relevant information are recorded during the standard measuring process of the test sieve and confirmed in the required certificate.

## 13 Disposal

In the case of a disposal, the respective statutory requirements must be observed. In the following, information on the disposal of electrical and electronic devices in the European Community are given.

Within the European Community the disposal of electrically operated devices is regulated by national provisions that are based on the EU Directive 2012/19/EU on Waste Electrical and Electronic Equipment (WEEE).

Accordingly, all devices supplied after August 13<sup>th</sup> 2005 in the business-to-business area, to which this product is classified, may no longer be disposed of with municipal or household waste. To document this, the devices are provided with the disposal label.

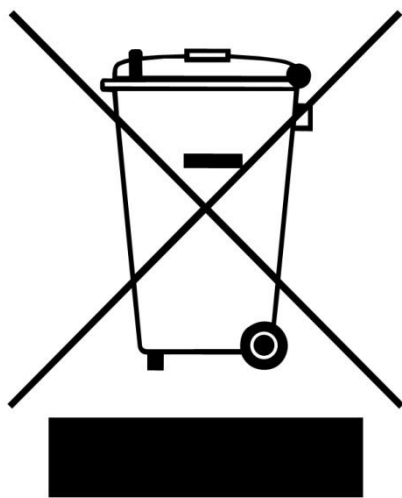

**Fig. 31:** Disposal label

Since the disposal regulations worldwide and also within the EU may differ from country to country, the supplier of the device should be consulted directly in case of need.

This labelling obligation is applied in Germany since March 23<sup>rd</sup> 2006. From this date on, the manufacturer must provide an adequate possibility of returning all devices delivered since August 13<sup>th</sup> 2005. For all devices delivered before August 13<sup>th</sup> 2005 the end user is responsible for the proper disposal.

## 14 Index

### A

Accessories .....	50
Action instructions.....	7
Activatable parameters .....	34
Adapter ring .....	23, 24
Adjustable parameters.....	33
Air inlet duct .....	29
Air outlet duct.....	29
Ambient temperature .....	15
Amperage .....	16
Application-technical information.....	6
Automatic vacuum regulation adjustment.....	51
Automatic vacuum regulator connecting.....	50
Automatische Unterdruckregelung Montage .....	51

### B

Back .....	29
Back view.....	29
Bar code .....	16
Basic settings.....	38
Brightness.....	39

### C

Calibration.....	41, 45
sensor.....	41
Calibration service .....	55
Capacity .....	16
CE marking .....	16
Certificate.....	55
Cleaning.....	46
Complaints.....	14
Condensation.....	14
Confirmation form for the managing operator.....	10
Control element .....	32
Control panel areas .....	32
language .....	39
Control range .....	51
Control unit .....	28, 33
Controlling the device .....	32
Copyright .....	6
Cyclone lid .....	52
Cyclone separator.....	52
bracket.....	52
connecting.....	53
mounting .....	53

### D

Date .....	39
Deactivatable parameters.....	34
Degree of protection .....	11
Depth .....	12
base.....	12

Device designation.....	16
Device information .....	32
Device interface .....	29
Dimensions .....	12
Disclaimer .....	6
Disconnection from the mains .....	18
Display .....	32
Displays .....	32
Disposal .....	56
label.....	56
regulations.....	56
Disposal label.....	16

### E

EasySieve® .....	31, 41, 43
Electrical connection .....	15, 16
Electromagnetic compatibility .....	11
EMC .....	11
Emissions.....	11
Equivalent continuous sound level .....	11
Error E11 .....	44
E24 .....	44
E25 .....	44
E83 .....	44
E84 .....	44
Error messages.....	40, 44
Evaluation .....	43
Explanations of the safety instructions .....	7
External fuse .....	16

### F

Feed grain size .....	13
Feed quantity .....	12
First commissioning .....	18
Frequency .....	16
Front.....	28
Front view .....	28
Functions .....	32
Fuse external.....	16
Fuse strength .....	16
Fuse type .....	16

### G

General catalogue.....	50
General safety instructions .....	8
Grain size range .....	26

### H

Hearing damage .....	11, 50
Height.....	12
Humidity .....	15

### I

IEC power connection.....	29
---------------------------	----

Industrial vacuum cleaner.....	22	Operating modes .....	33
connecting.....	22	Operating the device.....	26
connection.....	29	<b>P</b>	
Information note		Packaging .....	14
H45.....	44	Parameter	
Information notes .....	44	save.....	35
Installation.....	14	Part number .....	16
Installation height.....	15	Particle distribution.....	43
Installation of the device .....	17	Particle size analysis.....	43
Installation site		Particle size characteristics .....	43
conditions .....	15	Particle size distribution .....	26
Interface .....	40	Particle size range .....	13
RS232 .....	40	Payload .....	13
USB .....	40	Performing a sieving .....	30
<b>L</b>		Power version .....	16
Languages .....	39	Pressure sensor	
$L_{eq}$ .....	11	calibration .....	48
Location requirements .....	12	Principle of operation .....	27
Long-term operation .....	27	Process	
<b>M</b>		start.....	36
Mains connection.....	29	start with Quick start.....	37
Mains frequency .....	16	stop.....	36
Mains supply .....	16	Programme	
Mains switch .....	29	deleting .....	38
Maintenance .....	10, 45, 46, 48	editing .....	37
Manometer.....	49	saving .....	38
Manual .....	6, 8, 10	selecting .....	37
Manual mode .....	33, 35	Programme memory position.....	37
Manual vacuum regulation		Programme mode .....	33, 35, 37
adjustment.....	20	<b>Q</b>	
connecting.....	20	Quick start	
functional principle .....	19	assign parameters.....	36
Manufacturer's address .....	16	Quick Start .....	36
Materials .....	26	QUICK START .....	33
Measurement range.....	13	<b>R</b>	
Measurement report .....	43	Range of application of the device.....	27
<b>N</b>		Rated power.....	11
Navigation .....	32, 33	Receptacle .....	52
Neg. pressure .....	33, 34	Receptacle volume .....	12
Negative pressure.....	13, 38	Relative humidity	
maximum.....	13	maximum.....	15
Negative pressure sensor.....	41	Repair .....	9, 45, 48
Notes on the manual.....	6	Repair instructions .....	6, 9, 48
Nozzle .....	28	Required floor space.....	12
Nozzle chamber .....	28	Return .....	14
<b>O</b>		for service and maintenance .....	45
Open Mesh .....	34	Return device .....	56
Operating controls .....	32	Return form .....	45
Operating hours .....	41	Revision status.....	6
Operating instructions.....	10	Rotary push button.....	28, 33
Operating mode		RS232 interface .....	29
change.....	33	<b>S</b>	
manual.....	33	Safety instruction .....	7
programme.....	33	caution .....	7
quick start.....	33	danger .....	7
selection .....	33	notice .....	8

warning.....	7	Technical data.....	11
Safety manager .....	8	Temperature fluctuations .....	14
Scale .....	43	Temperature range .....	15
Sealing screw .....	48	Temporary storage.....	14
Serial number .....	16, 41	Test sieve.....	26, 30, 54
Service .....	41	cleaning .....	46
Service address .....	9	diameter .....	18
Service environment.....	41	drying.....	47
Service level .....	41	insert.....	23
Settings .....	32	maximum drying temperature .....	47
Sieve diameter .....	13	Time .....	40
Sieve lid .....	29	Transport.....	14
label.....	24	Transport damage.....	14
shape.....	24	Type plate .....	16, 29
Sieve lids .....	24	description .....	16
Sieving aids .....	13	<b>U</b>	
Sieving parameters.....	33	UKCA marking .....	16
Sieving time .....	33, 34	USB interface.....	29
Signal tone.....	40	Use of the device for the intended purpose .....	26
Signs .....	7	<b>V</b>	
Silencer.....	18, 28	Vac cleaner .....	34, 35
Small accessories.....	50	Vacuum regulation	
Soft-faced mallet.....	31	automatic.....	21, 29, 50
usage.....	31	manual.....	19, 28, 52
Software.....	43	Value input .....	34
Software update.....	41	Views of the instrument.....	28
Software version		Voltage .....	16
controller .....	41	<b>W</b>	
display .....	41	Warning tone.....	40
Sound level .....	11, 50	Warranty claims .....	9, 14
Sound parameters .....	11	Wear.....	46, 47
Spare parts .....	50	Wear parts .....	50
Speed.....	33, 34	Weight .....	12, 16
Standby mode.....	30	Wet sieving .....	13
START .....	32	Width.....	12
STOP .....	32	base.....	12
Suction device .....	22	Working space .....	12
Suction noises .....	11	Workplace related emission level .....	11
Switching on / off .....	30	<b>Y</b>	
Symbols .....	7	Year of production.....	16
<b>T</b>			
Target group .....	8		

# AIR JET SIEVING MACHINE

AS 200 jet | 30.027.xxxx

## EU DECLARATION OF CONFORMITY

We, represented by the undersigned, hereby declare that the above device complies with the following directives and harmonised standards:

### Machinery Directive 2006/42/EC

Applied standards, in particular:

DIN EN ISO 12100	Machine Safety - General Design Principles
DIN EN 61010-1	Safety Regulations for Electrical Measurement, Control, Regulation and Laboratory Devices

### Electromagnetic compatibility 2014/30/EU (tested at 230 V, 50 Hz)

Applied standards, in particular:

EN 55011	Industrial, scientific and medical equipment - Radio-frequency disturbance characteristics - Limits and methods of measurement
DIN EN 61326-1	Electrical equipment for measurement, control and laboratory use - EMC requirements

### Restriction of hazardous substances (RoHS) 2011/65/EU

### Authorised person for compilation of the technical documentation:

Julia Kürten (Technical Documentation)

Furthermore, we declare that the relevant technical documentation for the above device has been prepared in accordance with Annex VII Part A of the Machinery Directive and we undertake to submit the documentation to the market surveillance authorities on request.

**In the event of a modification of the device not agreed on by Retsch GmbH, as well as the use of non-approved spare parts or accessories, this declaration loses its validity.**

Retsch GmbH

Haan, 09/2023



Dr. Frank Janetta, Head of Development





**Retsch**<sup>®</sup>

**Copyright**

© Copyright by  
Retsch GmbH  
Retsch-Allee 1-5  
42781 Haan  
Germany