

Manual

Tap Sieve Shaker AS 200 tap

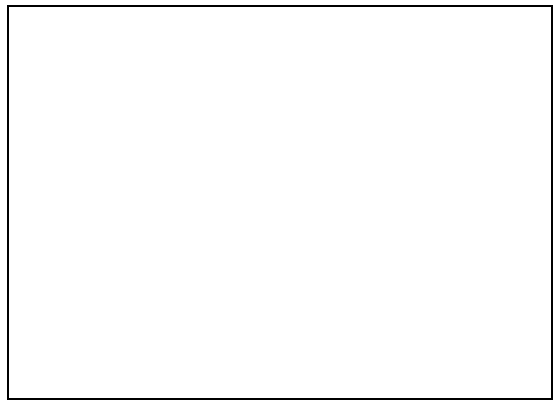

Translation

Retsch[®]

Copyright

© Copyright by
Retsch GmbH
Retsch-Allee 1-5
42781 Haan
Germany

Table of Contents

1	Notes on the manual	6
1.1	Explanation of signs and symbols	6
1.2	Disclaimer	6
1.3	Copyright.....	6
1.4	Explanations of the Safety Instructions	7
1.5	General Safety Instructions	8
1.6	Repairs.....	9
1.7	Confirmation Form for the Managing Operator.....	11
2	Technical Data	12
2.1	Degree of Protection	12
2.2	Emissions.....	12
2.3	Electromagnetic Compatibility (EMC).....	12
2.4	Rated Power	13
2.5	Dimensions and Weight.....	13
2.6	Required Floor Space	13
2.7	Receptacle Volume.....	13
2.8	Feed Grain Size	14
2.9	Payload	14
2.10	Suitable Sieve Diameters	14
2.11	Drive.....	14
3	Packaging, Transport and Installation	15
3.1	Packaging	15
3.2	Transport.....	15
3.3	Temperature Fluctuations and Condensation	15
3.4	Conditions for the Installation Site	16
3.5	Electrical Connection	17
3.6	Type Plate Description.....	17
3.7	Removing the Transportation Lock.....	18
3.8	Transportation Aid	18
4	First Commissioning	21
4.1	Connecting the Safety Plug	22
4.2	Inserting the Test Sieves	23
5	Operating the Device	26
5.1	Use of the Device for the Intended Purpose.....	26
5.2	Principle of Operation	27
5.3	Views of the device	28
5.3.1	Front.....	28
5.3.2	Back	29
5.4	Switching On / Off.....	29
5.5	Selection of the Test Sieves	30
5.6	Performing a Sieving	30
6	Controlling the Device	31
6.1	Operating Controls, Displays and Functions	31
6.1.1	Start Process	31
6.1.2	Stop Process.....	31
6.2	Pause Process.....	31
6.3	Time	32
7	EasySieve®	33
8	Return for Service and Maintenance	34
9	Cleaning, Wear and Maintenance	35
9.1	Cleaning.....	35
9.1.1	Cleaning of Test Sieves	35

9.1.1.1	Cleaning of Test Sieves with Mesh Sizes > 500 µm	35
9.1.1.2	Cleaning of Test Sieves with Mesh Sizes < 500 µm	35
9.1.1.3	Drying of Test Sieves.....	36
9.2	Wear	36
9.3	Maintenance	37
10	Accessories	38
10.1	Test Sieves	38
10.1.1	Certificate.....	38
10.1.2	Calibration Service.....	39
10.2	Sieving Aids	39
11	Disposal.....	40
12	Index	41



1 Notes on the manual

This manual provides technical guidelines for the safe operation of the device. Read this manual through carefully before installing, putting into service and operating the device. Reading and understanding this manual is essential for handling the device safely and as intended.

This manual does not contain any repair instructions. Please contact your supplier or contact Retsch GmbH directly if anything is unclear or you have questions about these guidelines or the device, or in the case of any faults or necessary repairs.

You can find further information about your device at <http://www.retsch.com> on the pages for the specific device concerned.

Amendment status:

The document amendment 0002 of the "Tap Sieve Shaker AS 200 tap" manual has been prepared in accordance with the Machinery Directive 2006/42/EC.

1.1 Explanation of signs and symbols

In this document the following **signs and symbols** are being used:

①	Reference to a recommendation and/or an important information
→	Reference to a chapter, table or figure
⇒	Action instruction
Name	Software menu function
[Name]	Software button
<Name>	Software checkbox

1.2 Disclaimer

This manual has been prepared with great care. We reserve the right to make technical changes. We assume no liability for personal injuries resulting from the failure to follow the safety information and warnings in this manual. No liability will be assumed for damage to property resulting from the failure to follow the information in this manual.

1.3 Copyright

This document or parts of it or its content may not be reproduced, distributed, edited or copied in any form without prior written permission of Retsch GmbH. Damage claims shall be asserted in the case of infringements.

1.4 Explanations of the Safety Instructions

In this document the following **signs and symbols** are being used:

ⓘ	Reference to a recommendation and/or an important information
→	Reference to a chapter, table or figure
⇒	Action instruction
Name	Software menu function
[Name]	Software button
<Name>	Software checkbox

DANGER

D1.0000

Risk of fatal injuries
Source of danger

- Possible consequences if the danger is ignored.
- **Instructions and information on how to avoid the risk.**

Fatal or serious injuries may result if the “Danger” sign is disregarded. There is a **very high risk** of a life-threatening accident or lasting personal injury. The signal word **DANGER** is additionally used in the running text or in instructions.

WARNING

W1.0000

Risk of life-threatening or serious injuries
Source of danger

- Possible consequences if the danger is ignored.
- **Instructions and information on how to avoid the risk.**

Life-threatening or serious injuries may result if the “Warning” sign is disregarded. There is an **increased risk** of a serious accident or of a possibly fatal personal injury. The signal word **WARNING** is additionally used in the running text or in instructions.

CAUTION

C1.0000

Risk of injuries
Source of danger

- Possible consequences if the danger is ignored.
- **Instructions and information on how to avoid the risk.**

Average to slight injuries may result if the “Caution” sign is disregarded. There is an average or slight risk of an accident or personal injury. The signal word **CAUTION** is additionally used in the running text or in instructions.

NOTICE

N1.0000

Type of damage to property

Source of the damage to property

- Possible consequences if the information is ignored.
 - **Instructions and information on how to avoid the damage to property.**

Damage to property may result if the information is disregarded. The signal word **NOTICE** is additionally used in the running text or in instructions.

1.5 General Safety Instructions

WARNING

W2.0012

Risk of injury
Incomplete device

- There is a risk of serious injury during commissioning without proper assembly of the safety devices.
- **When installing the device, pay particular attention to the proper installation of all necessary safety devices to comply with the harmonized standard DIN EN ISO 12100.**
- **Do not operate the device until all of the components listed in the Declaration of Incorporation have been installed and the device complies with the provisions of the Machinery Directive and the EC Declaration of Conformity in accordance with Part A of Annex II.**

CAUTION

C2.0002

Risk of injury
Lack of knowledge of the manual

- The manual contains all safety-related information. Disregarding the manual can therefore lead to injuries.
- **Read the manual carefully before operating the device.**

The Tap Sieve Shaker AS 200 tap of Retsch GmbH is delivered with a Declaration of Incorporation according to the Machinery Directive 2006/42/EC, Annex II, Part B.

NOTICE After the protective guards have been installed by the operator (owner), the safety plug must be connected for commissioning (→ Chapter "[Connecting the Safety Plug](#)").

Target group

All those operating, cleaning or working with or on the device.

This device is a modern, powerful product from Retsch GmbH and has been developed in line with the state-of-the art. The device is safe to use when operated correctly and when following the instructions in this manual.

Safety Officer

The operating company itself must ensure the following with respect to persons authorised to work on the device:

- that they have read and understood all regulations contained in the chapter on safety;
- that they are aware before they start work of all instructions and regulations for the target group related to the work;

- that they have easy access to the manual for this device at all times;
- that they have been familiarised with the safe and correct handling of the device before starting work on it, by means of a verbal introduction by a competent person and/or using this manual.

⚠ Improper operation can lead to personal injuries. The operating company itself is responsible for its safety and that of its staff. The operating company itself must ensure that no unauthorised persons have access to the device.

⚠ People under the influence of intoxicating substances (medications, drugs, alcohol) or who are overtired may not operate the device or work on the device.

⚠ CAUTION

C3.0015

Risk of injury

Improper modifications to the device

- Improper modifications to the device can result in injuries.
- **Do not make any unauthorised changes to the device.**
- **Only use the spare parts and accessories approved by Retsch GmbH!**

NOTICE

N2.0012

Changes to the device

Improper modifications

- The conformity declared by Retsch GmbH with the European Directives will lose its validity.
- Any warranty claims will be terminated.
- **Do not make any modification to the device.**
- **Use spare parts and accessories that have been approved by Retsch GmbH exclusively.**



1.6 Repairs

This manual does not contain any repair instructions. For safety reasons, repairs may only be carried out by Retsch GmbH or an authorised representative or by qualified service technicians.

In case of repair, please inform...

- ...the Retsch GmbH representative in your country,
- ...your supplier, or
- ...Retsch GmbH directly.

Service address:

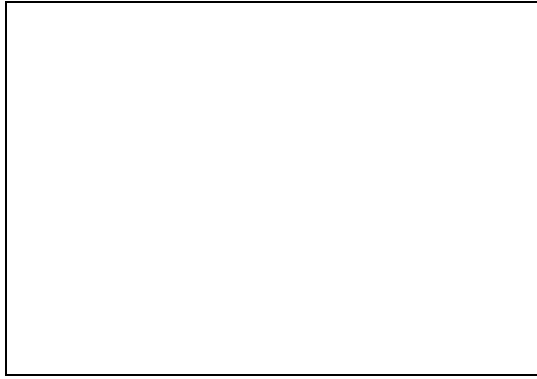

1.7 Confirmation Form for the Managing Operator

This manual contains essential instructions for operating and maintaining the device which must be strictly observed. It is essential that they be read by the user and by the qualified staff responsible for the device before the device is commissioned. This manual must be available and accessible at the place of use at all times.

The user of the device herewith confirms to the managing operator (owner) that he has received sufficient instructions about the operation and maintenance of the system. The user has received the manual, has read and taken note of its contents and consequently has all the information required for safe operation and is sufficiently familiar with the device.

The managing operator should for legal protection have the user confirm the instruction about the operation of the device.

I have read and taken note of the contents of all chapters in this manual as well as all safety instructions and warnings.

User

Surname, first name (block letters)

Position in the company

Place, date and signature

Managing operator or service technician

Surname, first name (block letters)

Position in the company

Place, date and signature

2 Technical Data

2.1 Degree of Protection

- IP40

2.2 Emissions

⚠ CAUTION

C4.0011

Possibility of acoustic signals not being heard

Loud sieving noises

- Possible acoustic alarms and voice communication might not be heard.
- **Consider the volume of the sieving noise in relation to other acoustic signals in the work environment. Additional visual signals may be used.**

⚠ CAUTION

C5.0025

Hearing damage

A high sound level may be generated depending on the type of material, the number of sieves, the sieving aid used and the duration of the sieving

- Excessive noise in terms of level and duration can cause impairments or permanent damage to hearing.
- **Ensure suitable noise protection measures are taken or wear ear protection.**



Sound parameters:

The sound parameters are also influenced by the number of test sieves and the properties of the sample material.

Example 1:

Number of test sieves:	5
Feed material:	Quartz sand (< 1 mm)
Soundproof hood:	no

At these operating conditions, the workplace related equivalent continuous sound level $L_{eq} = 95 \text{ dB(A)}$.

Example 2:

Number of test sieves:	5
Feed material:	Quartz sand (< 1 mm)
Soundproof hood*:	yes

*of Retsch GmbH

At these operating conditions, the workplace related equivalent continuous sound level $L_{eq} = 80 \text{ dB(A)}$.

2.3 Electromagnetic Compatibility (EMC)

- EMC class according to DIN EN 55011: B

2.4 Rated Power

~ 315 VA

2.5 Dimensions and Weight

- Height: ~ 640 mm
- Width: 700 mm
- Depth: 450 mm
- Weight without sieve stack: ~ 68 kg

2.6 Required Floor Space

- Width of the base: 800 mm
- Depth of the base: 550 mm
- No safety clearances required

Location requirements:

The device must be placed on a vibration-free, plane, stable and free surface to avoid transmission of vibrations. A level base ensures the uniform distribution of the sample over the sieve mesh fabric, as well as the stability of the device.

NOTICE

N3.0023

Location requirements

Unbalance and vibration during operation

- The AS 200 tap causes strong unbalance and vibrations during the operation, which can lead to a movement of the whole device.
- **The installation must be carried out on a stable, anti-slip, vibration-free base, which is suitable for both, the weight of the device and the resulting vibrations during operation.**
- **In order to ensure safe operation, the AS 200 tap has to be screwed firmly to the base by means of the transport angles.**

2.7 Receptacle Volume

The maximum receptacle volume (the maximum feed quantity) depends on various factors such as number and aperture size of the test sieves, maximum grain size and width of distribution of the sample material.

Examples for the maximum feed quantity according to DIN 66165 for test sieves of 200 mm in diameter are listed in the following table:

Mesh size	Max. feed quantity	Max. permitted oversize material according to DIN 66165
25 µm	14 cm ³	7 cm ³
45 µm	20 cm ³	10 cm ³
63 µm	26 cm ³	13 cm ³
125 µm	38 cm ³	19 cm ³
250 µm	58 cm ³	29 cm ³
500 µm	88 cm ³	44 cm ³
1 mm	126 cm ³	63 cm ³
2 mm	220 cm ³	110 cm ³
4 mm	346 cm ³	173 cm ³

8 mm	566 cm ³	283 cm ³
------	---------------------	---------------------

2.8 Feed Grain Size

Traditional dry sieving is performed in the particle size range of 40 µm to 125 mm. By means of sieving aids or with wet sieving the measurement range can be extended to 20 µm. The maximum feed grain size depends on the sample material, the number and aperture size of the test sieves and the type of the sieving machine.

Examples for the maximum feed grain size according to DIN 66165 are listed in the following table:

Mesh size	Max. feed grain size according to DIN 66165	Mesh size	Max. feed grain size according to DIN 66165
22 µm	710 µm	4 mm	25 mm
45 µm	1 mm	8 mm	45 mm
63 µm	1.4 mm	16 mm	71 mm
125 µm	2.5 mm	22.4 mm	90 mm
250 µm	4 mm	45 mm	150 mm
500 µm	6 mm	63 mm	180 mm
1 mm	10 mm	90 mm	230 mm
2 mm	16 mm	125 mm	300 mm

The Tap Sieve Shaker AS 200 tap is designed for the measurement range of 20 µm to 25 mm.

2.9 Payload

- Maximum sample quantity: 3 kg
- Maximum sieve stack weight: 3 kg
- Maximum payload: 6 kg (sample material plus test sieves)
- Maximum sieve stack height: 380 mm
- Maximum number of fractions: 7 (height of test sieves and collecting pan: 50 mm (2")) / 13 (height of test sieves and collecting pan: 25 mm (1"))

2.10 Suitable Sieve Diameters

- Suitable sieve diameters: 200 mm / 203 mm (8")

2.11 Drive

- Horizontal circular motions: 280 rpm (+/- 2 rpm)
- Taps: 150 min

3 Packaging, Transport and Installation

3.1 Packaging

The packaging has been adapted to the mode of transport. It complies with the generally applicable packaging guidelines.

NOTICE

N4.0001

Complaint or return

Keeping the packaging

- Inadequate packaging and insufficient securing of the device can jeopardise the warranty claim in the event of a complaint or return.
- **Keep the packaging for the duration of the warranty period.**

3.2 Transport

NOTICE

N5.0017

Damage to components

Transport

- Mechanical or electronic components may be damaged during transport.
- **The device must not be knocked, shaken or thrown during transport.**

NOTICE

N6.0014

Complaints

Incomplete delivery or transport damage

- The forwarding agent and Retsch GmbH must be notified immediately in the event of transport damage. It is otherwise possible that subsequent complaints will not be recognised.
- **Please check the delivery on receipt of the device for its completeness and intactness.**
- **Notify your forwarding agent and Retsch GmbH within 24 hours.**

3.3 Temperature Fluctuations and Condensation

NOTICE

N7.0016

Damaged components due to condensation

Temperature fluctuations

- The device may be exposed to substantial fluctuations in temperature during transport. The ensuing condensation can damage electronic components.
- **Wait until the device has acclimatised before putting it into service.**

Temporary storage:

Also in case of an interim storage the device must be stored dry and within the specified ambient temperature range.

3.4 Conditions for the Installation Site

NOTICE

N8.0021

Ambient temperature

Temperatures outside the permitted range

- Electronic and mechanical components may be damaged.
- The performance data alter to an unknown extent.
- **Do not exceed or fall below the permitted temperature range (5 °C to 40 °C ambient temperature) of the device.**
- Installation height: max. 2 000 m above sea level
- Ambient temperature: 5 °C – 40 °C
- Maximum relative humidity < 80 % (at ambient temperatures ≤ 31 °C)

For ambient temperatures U_T between 31 °C and 40 °C, the maximum relative humidity value L_F linearly decreases according to $L_F = -(U_T - 55) / 0.3$:

Ambient temperature	Max. rel. humidity
≤ 31 °C	80 %
33 °C	73.3 %
35 °C	66.7 %
37 °C	60 %
39 °C	53.3 %
40 °C	50 %

NOTICE

N9.0015

Humidity

High relative humidity

- Electronic and mechanical components may be damaged.
- The performance data alter to an unknown extent.
- **The relative humidity in the vicinity of the device should be kept as low as possible.**

3.5 Electrical Connection

⚠ WARNING W3.0015

Risk to life caused by an electric shock
 Connection to socket without a protective earth conductor

- Connecting the device to sockets without a protective earth conductor can lead to life-threatening injuries caused by an electric shock.
- **Always operate the device using sockets with a protective earth conductor (PE).**



NOTICE N10.0022

Electrical connection
 Failure to observe the values on the type plate

- Electronic and mechanical components may be damaged.
- **Connect the device only to a mains supply matching the values on the type plate.**

- ⚠ WARNING** When connecting the power cable to the mains supply, use an external fuse that complies with the regulations applicable to the place of installation.
- Check the type plate for details on the necessary voltage, frequency, and maximum external current source fuse for the device.
 - The listed values must agree with the existing mains supply.
 - Only use the supplied power cable to connect the device to the mains supply.

3.6 Type Plate Description

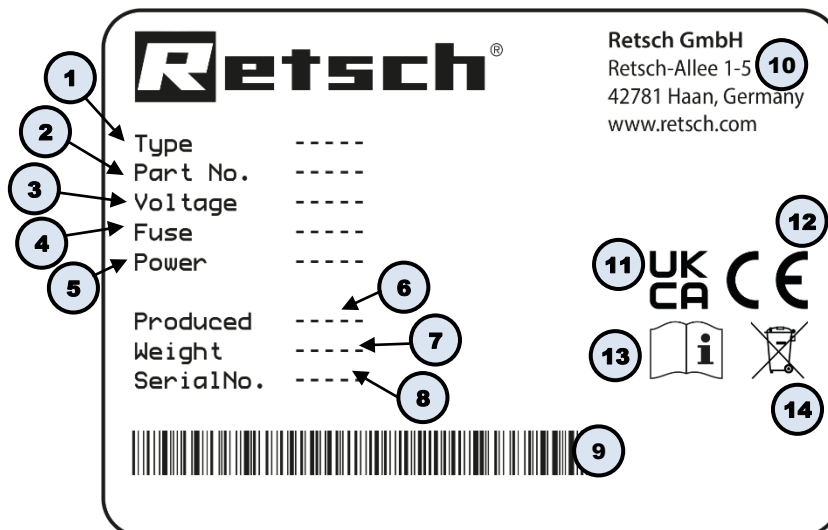

Fig. 1: Type plate

- 1 Device designation
- 2 Part number
- 3 Power version, Mains frequency
- 4 Fuse type and fuse strength
- 5 Capacity, Amperage
- 6 Year of production
- 7 Weight

- 8 Serial number
- 9 Bar code
- 10 Manufacturer's address
- 11 UKCA marking
- 12 CE marking
- 13 Safety warning: Read the manual
- 14 Disposal label

① In the case of queries please provide the device designation (1) or part number (2), as well as the serial number (8) of the device.

3.7 Removing the Transportation Lock

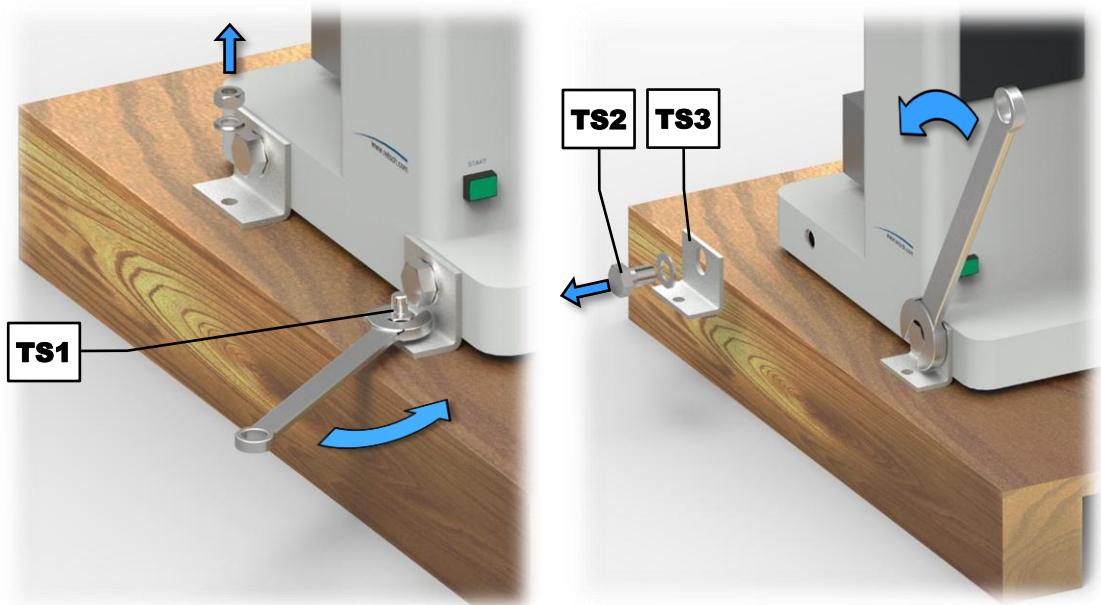

Fig. 1: Unscrewing the transportation lock

- ⇒ Loosen the four screws (TS1) securing the device to the pallet by means of an 18 mm open-end wrench and remove them.
- ⇒ Loosen the four screws (TS2) of the transport angles (TS3) on both sides of the device by means of a 30 mm open-end wrench and remove them.
- ⇒ Keep the transportation lock for later transport.

① The transport angles (TS3) can be used to securely screw the device to the base.

3.8 Transportation Aid

⚠

WARNING

W4.0005

Risk of injury due to the device falling down
Lifting the device above head height

- The device can fall causing serious injuries when lifted above head height.
- **Never lift the device above head height!**

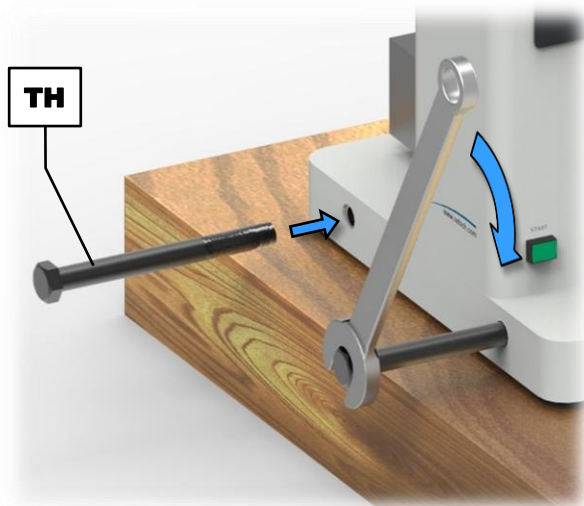

Fig. 2: Installing the transportation aid

⇒ Screw the four supplied transportation aids (**TH**) with a 30 mm open-end wrench into the existing threaded holes on both sides of the device.

⚠ CAUTION The weight without sieve stack amounts approx. 68 kg. The device may only be lifted by four people or with suitable hoist, that is designed for the weight.

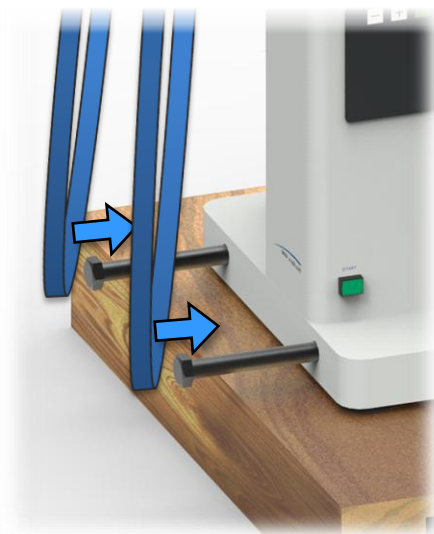

Fig. 3: Attaching lifting straps

Lifting straps should be used to lift the device with a suitable hoist.

⇒ Attach the lifting straps to the two transportation aids as shown in the figure.

NOTICE The housing can be damaged if the lifting straps are too short. The four lifting straps must be sufficiently long in order to observe a minimum distance of 85 cm between the device and the hoist.

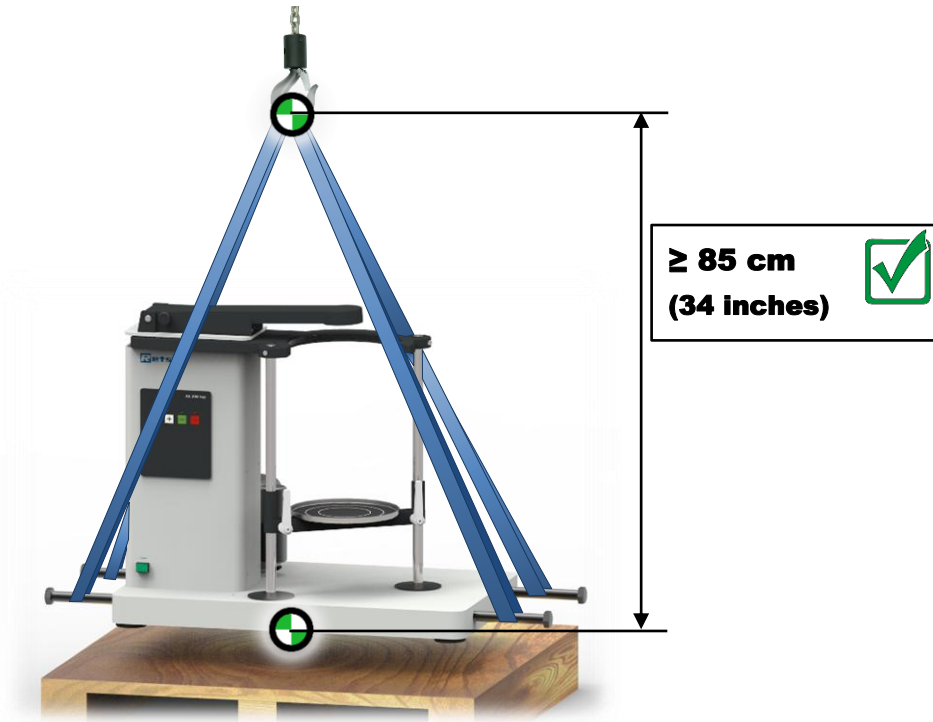



Fig. 4: Minimum distance between housing and hoist

4 First Commissioning

⚠ WARNING W5.0012

Risk of injury
Incomplete device

- There is a risk of serious injury during commissioning without proper assembly of the safety devices.
- **When installing the device, pay particular attention to the proper installation of all necessary safety devices to comply with the harmonized standard DIN EN ISO 12100.**
- **Do not operate the device until all of the components listed in the Declaration of Incorporation have been installed and the device complies with the provisions of the Machinery Directive and the EC Declaration of Conformity in accordance with Part A of Annex II.**



⚠ WARNING W6.0002

Danger to life through electric shock
Damaged power cable

- Operating the device with a damaged power cable or plug can lead to life-threatening injuries caused by an electric shock.
- **Before operating the device, check the power cable and plug for damage.**
- **Never operate the device with damaged power cable or plug!**



NOTICE N11.0002

Setting up the device
Disconnecting the device from the mains

- A separation of the device from the mains must be possible at any time.
- **Set up the device in such a way, that the connection for the power cable is always easily accessible.**

NOTICE N12.0023

Location requirements
Unbalance and vibration during operation

- The AS 200 tap causes strong unbalance and vibrations during the operation, which can lead to a movement of the whole device.
- **The installation must be carried out on a stable, anti-slip, vibration-free base, which is suitable for both, the weight of the device and the resulting vibrations during operation.**
- **In order to ensure safe operation, the AS 200 tap has to be screwed firmly to the base by means of the transport angles.**

NOTICE After the protective guards have been installed by the operator (owner), the safety plug must be connected for commissioning (→ Chapter "[Connecting the Safety Plug](#)").

The AS 200 tap is suitable for test sieves with an outer diameter of 200 mm and 203 mm (8"). Up to 13 fractions (12 test sieves plus collecting pan with a height of 25 mm), or 7 fractions (6 test sieves plus collecting pan with a height of 50 mm) can be clamped.

NOTICE A high number of test sieves can significantly increase the total weight of the load (sieve stack and sample material). Make sure not to exceed the maximum payload of 6 kg.

4.1 Connecting the Safety Plug

On delivery, a cover (**PA**) marked with a red dot is plugged in the safety plug connection (**L**).

In consideration of the selected protective guards, either the safety plug (**PS**) included in the scope of delivery and marked with a green dot can be plugged in, or the local protective guards can be looped in via the safety plug connection (**L**).

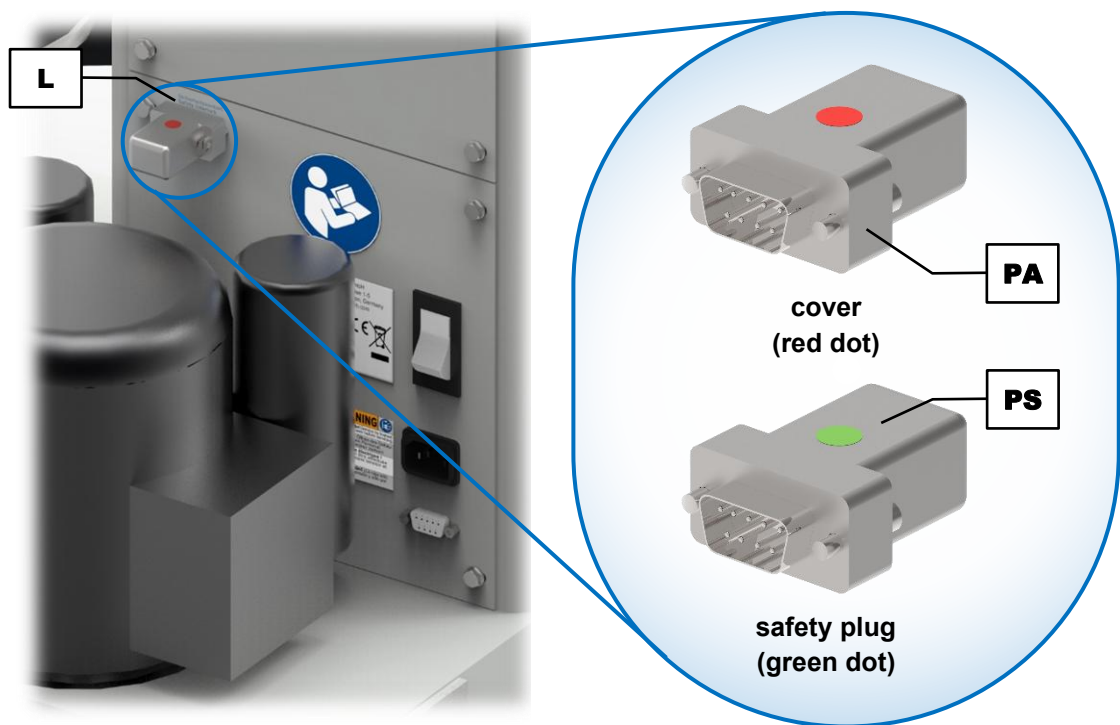



Fig. 5: Safety plug connection on the device



⚠ WARNING When using the safety plug (**PS**), it must be ensured that the operator is protected from inadvertently accessing the device!

⇒ Remove the cover (**PA**) and connect the safety plug (**PS**) to the connection (**L**).

By trained personnel, additional protective guards can be connected to the connection (**L**) instead of the safety plug (**PS**). On delivery, the AS 200 tap is in "P1" programme mode. In this programme mode, the device can only be started by simultaneously pressing the  button (**H2**) and the push button START (**G**).

After external protective guards has been looped in, the push button START (**G**) on the front side of the device can be deactivated by switching to "P2" programme mode.

⇒ Switch off the device.

⇒ When switching on again, press the  (**H3**) and  (**H4**) buttons of the time display simultaneously. "P2" appears in the time display.

⇒ Press the  button (**H1**) to enter the standby mode.

⇒ To return to the "P1" programme mode, repeat this process. "P1" appears in the time display.

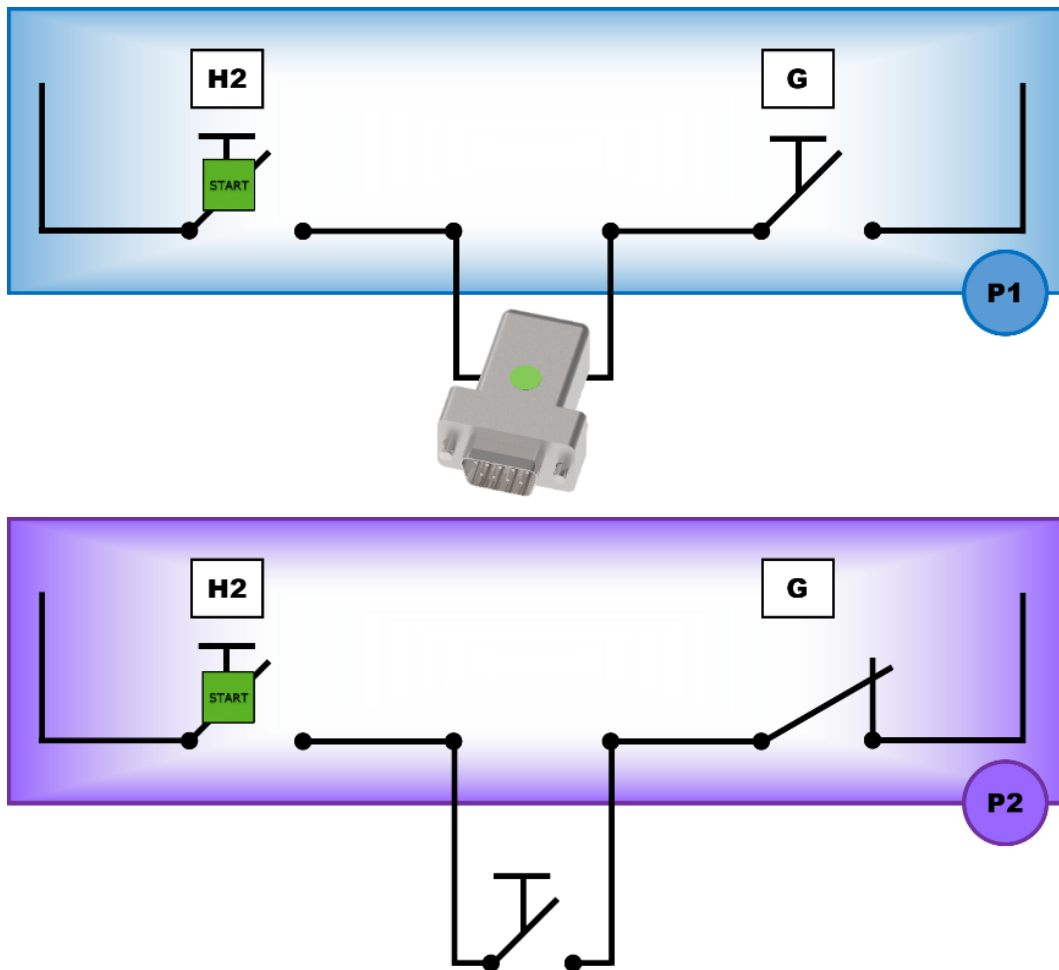

Fig. 6: Programm modes "P1" (top) and "P2" (bottom) of the device

4.2 Inserting the Test Sieves

⚠ CAUTION

C6.0012

Contusions and bruises

Overturning of the sieve stack

- The sieve stack can overturn and cause personal injury.
- **Only operate the device with securely clamped sieve stack.**

To insert the sieve stack more easily, the tapping arm (A) can be secured in an elevated position with the locking bolt (F).

- ⇒ Pull the locking bolt (F) forward to the stop.
- ⇒ Lift up the tapping arm (A), so that the bore of the tapping arm is at the same level with the locking bolt.
- ⇒ Turn the locking bolt (F) by approx. 90° to release the pin, and let go of the locking bolt. The pin of the locking bolt now secures the tapping arm.

To make it easier to loosen the clamping screws, the position of the clamping levers (B) can be adjusted independently of the clamping screws.

- ⇒ Pull the clamping levers (B) forward until they disengage audibly. The clamping levers can now be moved independently of the clamping screws.
- ⇒ Turn the clamping levers (B) to the desired position.

- ⇒ Press the clamping levers (**B**) backwards again until they engage audibly. The clamping levers are now again connected to the clamping screws.

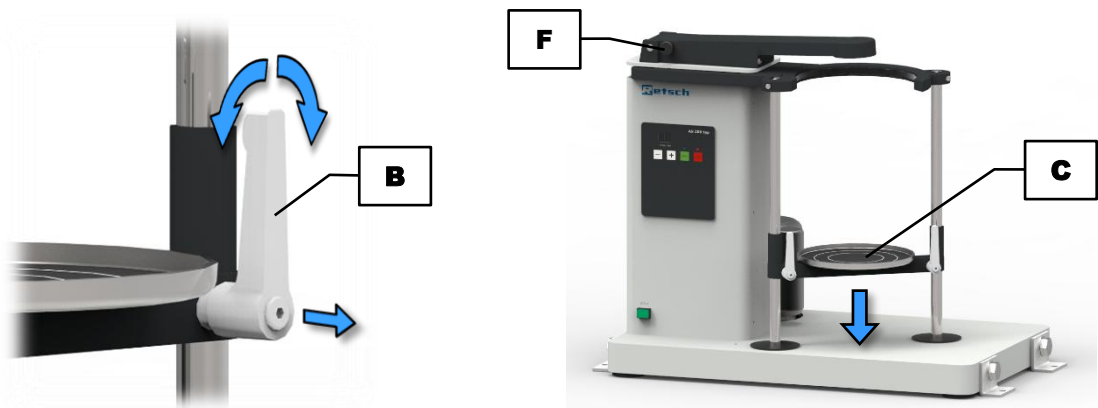

Fig. 7: Position the clamping lever (left), adjust the height of the sieve plate (right)

- ⇒ Loosen both clamping screws and slide the sieve plate (**C**) downwards.
- ⇒ Tighten both clamping screws again.
- ⇒ Place the desired [sieve stack](#) including the sample material and sieve lid (**D**) centrally on the sieve plate (**C**).
- ⇒ Then again, loosen both clamping screws and slide up the sieve plate (**C**) together with the sieve stack until the upper edge of the sieve lid forms a plane with the guide ring (**FR**).
- ⇒ Tighten both clamping screws again.
- ⇒ Release the tapping arm (**A**) again by pulling the locking bolt (**F**) forward again and rotating it by approx. 90°. The pin is now held inside the locking bolt and no longer engages with the tapping arm.

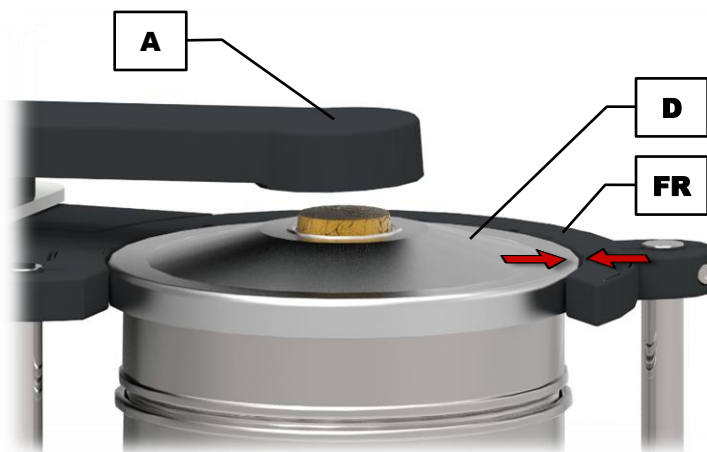

Fig. 8: Insert the sieve stack

Remove the sieve stack:

- ⇒ Secure the tapping arm (**A**) with the locking bolt (**F**) in an elevated position.
- ⇒ To remove the sieve stack after the sieving process, slightly lift up the sieve stack together with the sieve lid.
- ⇒ Pull the sieve stack out forwards.



Fig. 9: Remove the sieve stack

5 Operating the Device

5.1 Use of the Device for the Intended Purpose

⚠ CAUTION

C7.0005

Risk of injury

Potentially explosive atmosphere

- The device is not suitable for use in potentially explosive atmospheres. Operating the device in a potentially explosive atmosphere can lead to injuries caused by an explosion or fire.
- **Never operate the device in a potentially explosive atmosphere!**

⚠ CAUTION

C8.0006

Risk of injury

Sample material that is harmful to health

- Sample material that is harmful to health can injure people (illness, contamination).
- **Use suitable extraction systems with sample material that is harmful to health.**
- **Use suitable personal protective equipment with sample material that is harmful to health.**
- **Take note of the safety data sheets for the sample material.**



⚠ CAUTION

C9.0003

Risk of explosion or fire

Changing sample properties

- The properties and therefore also the hazardousness of the sample can alter during the sieving process.
- **Do not use any substances in this device which carry the risk of explosion or fire.**
- **Observe the material safety data sheets of the sample material.**



This Tap Sieve Shaker of the Retsch GmbH is a laboratory device. It is suitable for dry sieving of free-flowing, disperse materials in the grain size range from 20 µm to 25 mm.

In relevant standards, the combination of a horizontal circular motion with tapping impulses is specified for the sieving of certain products, such as activated carbon, abrasives, metal powders, spices and diamonds.

In order to meet these standards, especially where there are high demands regarding easy operability, speed, precision and reproducibility, the Tap Sieve Shaker of the Retsch GmbH is successfully deployed in the areas of research and development, quality control of raw materials, intermediate and final products, as well as for production monitoring.

The AS 200 tap is specially designed for test sieves with an outer diameter from 200 mm and 203 mm (8"). For an optimum measurement result it is recommended to exclusively use test sieves from Retsch GmbH.

⚠ WARNING

W7.0010

Handling of food, pharmaceutical and cosmetic products

Analysed products

- Food, pharmaceutical and cosmetic products, which were analysed with the device must not be consumed, used or circulated.
- **Dispose these substances in accordance with the applicable regulations.**

**NOTICE**

N13.0007

Range of application of the device

Long-term operation

- This laboratory device is designed for eight-hour single-shift operation with a duty cycle of 30 %.
- **This device may not be used as a production machine nor is it intended for continuous operation.**

NOTICE

N14.0005

Device damage due to liquids

Ingress of liquids into the interior of the device

- Mechanical and electronic components are damaged, and the function of the device is no longer ensured.
- **No wet sieving may be carried out with this device!**

5.2 Principle of Operation

The AS 200 tap works with a horizontal circular motion of the sieve stack. At the same time, vertical tapping impulses are transferred to the sieve stack by means of a tapping arm. With the circular motion and tapping impulses independent of the mains voltage, the worldwide comparability of the sieving process is ensured. According to relevant standards, 280 revolutions and 150 impulses per minute are predefined in the Tap Sieve Shaker and cannot be modified. The sieving time is digitally adjustable.

5.3 Views of the device

5.3.1 Front

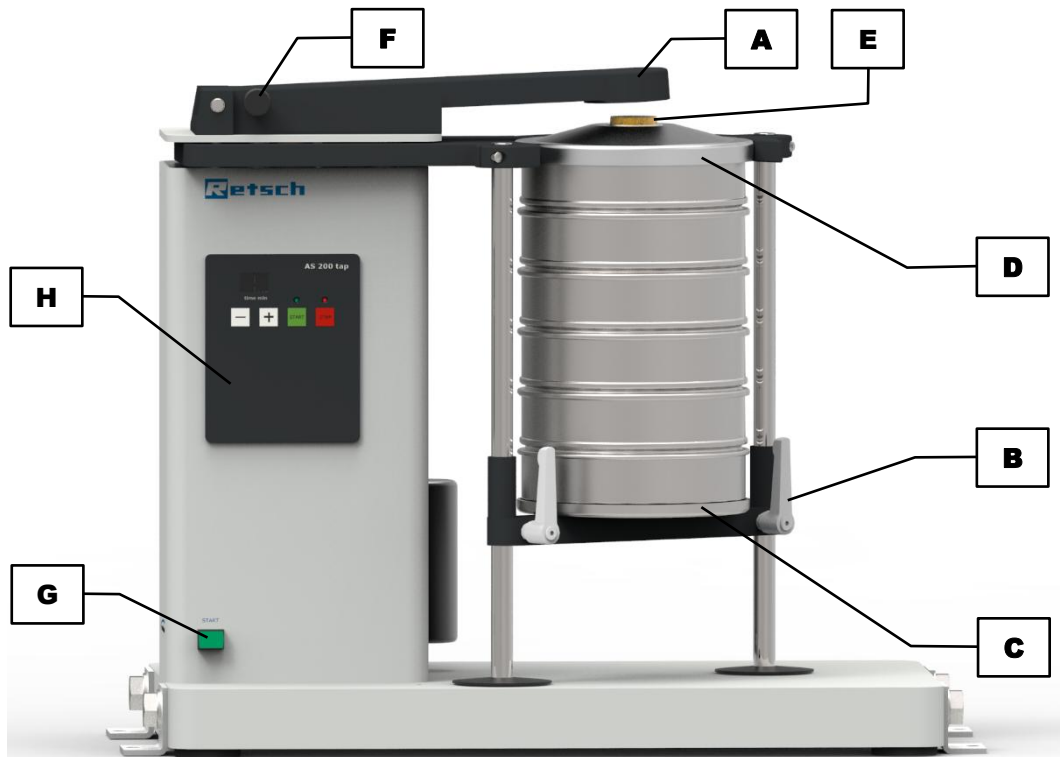



Fig. 10: Front view of the device

Element	Description	Function
A	Tapping arm	Transmits the tapping impulses via the cork stopper (E) to the sample material
B	Clamping lever	Allows the adjustment to different sieve stack heights
C	Sieve plate	Retains the sieve stack
D	Sieve lid	Centres the sieve stack and retains the cork stopper (E)
E	Cork stopper	Transmits the tapping impulses via the sieve lid (D) to the sample material
F	Locking bolt	Secures the tapping arm (A)
G	Push button START	Pressed simultaneously with the  button (H2), the push button starts the sieving process
H	Control unit	Operation of the device

5.3.2 Back



Fig. 11: Back view of the device

Element	Description	Function
I	Mains switch	Switches the device on and off, disconnects the device from the mains
J	Warning sign "Disconnect from the mains"	Warning of electric shock
K	Mains connection	Connection for the power cable
L	Safety plug connection	Monitors the contact of the protective guards
M	Type plate	Lists, among others, the voltage type, the serial number and the type of the device
N	Sticker "Manual"	Reminds to read the manual
O	RS232 interface	Data transfer between device and PC

5.4 Switching On / Off



⇒ Turn on the AS 200 tap with the mains switch (I) on the back side of the device.

When the device is switched off, it is completely disconnected from the mains.

Setting mode:

After switching on, the device is in the setting mode. The time display "time min" shows the last used value.

Standby mode:

By pressing the  button (**H1**) after power on, the device can be put into standby mode. In this mode, only the LED of the  button (**H1**) is lit. Except for the  button (**H2**), all buttons are inoperable.

5.5 Selection of the Test Sieves

The selection of the test sieves depends on the sample quantity as well as the particle size distribution. The gradation of mesh sizes and accordingly the measurement points should be selected in such a way that the complete particle size range of the sample is covered at regular intervals. The wider the particle size range, the more test sieves should be used.

5.6 Performing a Sieving

- ⇒ Determine the empty weights of the test sieves and the collecting pan.
- ⇒ Place the sieve stack with **increasing** mesh size on the collecting pan.

- ① Each test sieve is provided with an O-ring, which serves as a seal to minimise dust emission during the sieving.

- ⇒ Weigh the sample and put it on the uppermost test sieve (biggest mesh size). Make sure not to exceed the [maximum feed quantity](#).
- ⇒ Place the complete sieve stack centrally on the device and clamp the sieve stack (→ Chapter "[Inserting the Test Sieves](#)").
- ⇒ Set the sieving time (→ Chapter "[Controlling the Device](#)").
- ⇒ Start the sieving process.
- ⇒ After the end of the sieving process, weigh the individual test sieves and the collecting pan including the particle size fractions present therein.
- ⇒ Determine the mass of the particle size fractions (weight after the sieving less the respective empty weight).

- ① The evaluation software "[EasySieve](#)[®]" automatically records the weights and allows for a quick and simple evaluation of the sieve analysis. A detailed description can be found in the separate manual of the software.

6 Controlling the Device

6.1 Operating Controls, Displays and Functions

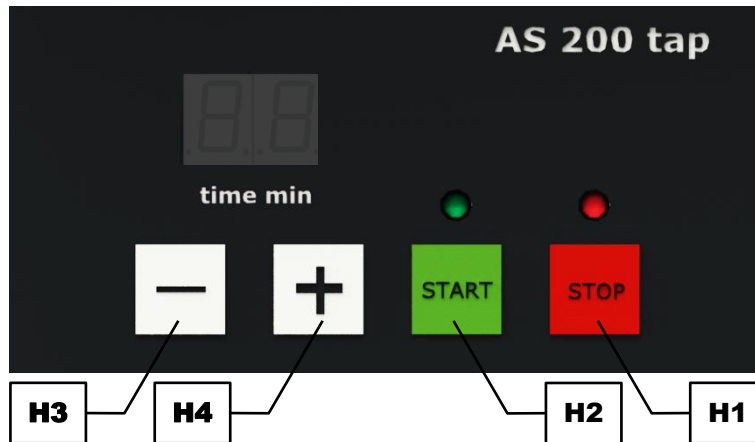



Fig. 12: Operating controls and functions

Element	Description	Function
H1	STOP	Stops the sieving process. In standby mode, the red LED is lit
H2	START	Starts the sieving process. During operation, the green LED is lit
H3	Minus button of the time setting	Reduces the sieving time in the range between 1 and 99 minutes
H4	Plus button of the time setting	Extends the sieving time in the range between 1 and 99 minutes

6.1.1 Start Process

- ⇒ To start the sieving process in the [setting mode](#), simultaneously press the  button (**H2**) and the push button START (**G**).
- ⇒ If the device is in [standby mode](#), simultaneously press the  button (**H2**) and the push button START (**G**) **twice** to start the sieving process.

The green LED lights up and the sieving process is started with the current settings.

6.1.2 Stop Process

The sieving process will stop automatically after the set process time has elapsed. However, the sieving process can be stopped manually at any time.

- ⇒ Press the  button (**H1**) **twice** to stop the sieving process.

6.2 Pause Process

The sieving process will stop automatically after the set process time has elapsed. However, the sieving process can be interrupted manually at any time.

- ⇒ Press the  button (**H1**) **once** to interrupt the sieving process.

The process time is stopped.

Continue the process:

- ⇒ Simultaneously press the  button (H2) and the push button START (G) to continue with the sieving process.

End the process:

- ⇒ Press the  button (H1) to end the sieving process.

6.3 Time

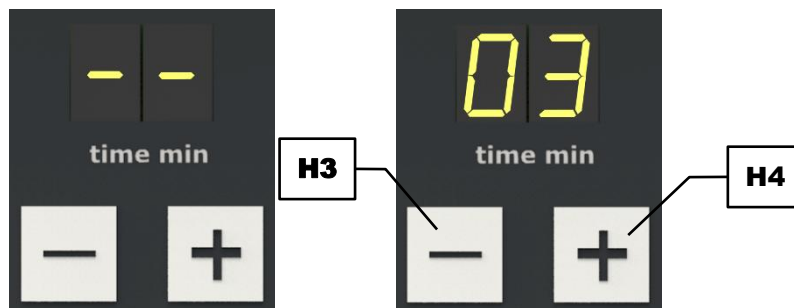









Fig. 13: Time setting for continuous operation (left) or with a process time (right)

The AS 200 tap can be operated either in continuous operation or for a certain time between 1 and 99 minutes. When the device is switched on, the last used setting is displayed.

- ⇒ Press the  (H4) or  (H3) button of the time display to set the desired process time.
- ⇒ Press and hold the  or  button to extend or reduce the process time in fast steps.
- ⇒ To change to the continuous operation, fall below the duration of 1 min by pressing the  button, or exceed the duration of 99 min by pressing the  button. The time display now indicates "--".

The process time can also be changed during operation by pressing the  or  button.

7 EasySieve®

EasySieve® is a software for particle size analysis and simplifies the manual evaluation in many respects. The software is able to automatically perform the required measuring and weighing processes – from determining the weights of the test sieves to evaluating the data.

The software is structured in a self-explanatory way and follows the logical chain of events involved in a particle size analysis. Therefore, the training period will be very short. The abundance of evaluation options provides absolute flexibility in adapting to demanding, individual tasks.

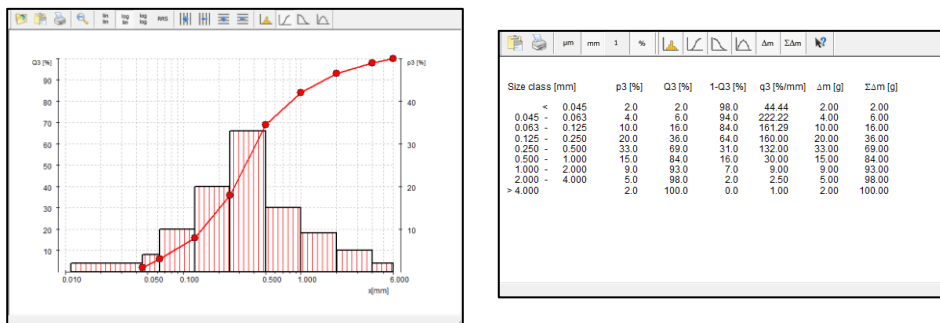

Fig. 14: Graphic and tabular presentation of the particle size analysis with EasySieve®

The software communicates with the scale and the AS 200 tap and guides the user through the respective steps. Available parameters, as well as the characteristics to be calculated can be entered in various edit boxes. Routine parameters can be edited, saved and recalled at any time.

If a scale is connected, the corresponding data (empty weights of test sieves, back weights of loaded test sieves) can be transferred directly to EasySieve®. If no scale is connected, the input can also be entered manually.

The software calculates all standard particle distributions, as well as the representative characteristics of the particle size, and allows for the tabular and graphical presentation of results in a measurement report conforming to standards. Furthermore, the data can be exported to other software products (e.g. Microsoft Excel).

EasySieve® is also available as AuditTrail enabled version in compliance with 21CFR Part 11.

① In case the sieve shaker is controlled via the software "EasySieve CFR", warning messages may appear in the Audit Trail stating that no serial number, no software version and no calibration date is received. Moreover, it may indicate, that no error number can be received. This is correct because the sieving machine does not support the provision of this data. Therefore, these warning messages in the Audit Trail do not constitute a reason for corrective measures.

① A detailed description can be found in the separate manual of the software.

8 Return for Service and Maintenance



Fig. 2: Return form

The acceptance of devices and accessories of the Retsch GmbH for repair, maintenance or calibration can only be effected, if the return form including the decontamination declaration service has been correctly and fully completed.

- ⇒ Download the return form located in the download section "Miscellaneous" on the Retsch GmbH homepage (<http://www.retsch.com/downloads/miscellaneous/>).
- ⇒ When returning a device, attach the return form to the outside of the packaging.

In order to eliminate any health risk to the service technicians, Retsch GmbH reserves the right to refuse the acceptance and to return the respective delivery at the expense of the sender.

9 Cleaning, Wear and Maintenance



9.1 Cleaning

WARNING

W8.0003

Risk to life caused by an electric shock
Cleaning live parts with water

- Cleaning the device with water can lead to life-threatening injuries caused by an electric shock if the device has not been disconnected from the power supply.
- **Only carry out cleaning work on the device when it has been disconnected from the power supply.**
- **Use a cloth moistened with water for cleaning.**
- **Do not clean the device under running water!**

NOTICE

N15.0009

Damage to the housing and device
Use of organic solvents

- Organic solvents may damage plastic parts and the coating.
- **The use of organic solvents is not permitted.**

⇒ Clean the housing of the device with a damp cloth and if necessary, with a household cleaning agent. Pay attention that no water or cleaning agent enters the interior of the device.

9.1.1 Cleaning of Test Sieves

Test sieves are measuring instruments and should be treated with due care before, during and after the sieving process. It is recommended to clean new test sieves before the first use from possible preservative residues with ethanol or isopropanol and to store them in a dry, dust-free place when unused.

Before cleaning or drying the test sieves, the O-rings have to be removed. Before using and after the cleaning the test sieves should be visibly inspected for possible damages and impurities.

Near-mesh or clamped particles can be often removed dry after the sieving process by slightly tapping the test sieve upside down with the sieve frame on a table. For test sieves with mesh sizes > 500 µm a fine hair brush can be used to sweep over the outer side of the mesh fabric.

9.1.1.1 Cleaning of Test Sieves with Mesh Sizes > 500 µm

Coarse mesh fabrics with mesh sizes > 500 µm can be cleaned dry or wet easily and effectively with a hand brush with plastic bristles (at not too high applied pressure).

9.1.1.2 Cleaning of Test Sieves with Mesh Sizes < 500 µm

Test sieves with mesh sizes < 500 µm should generally only be cleaned in an ultrasonic cleaning-bath. As cleaning agent, water together with a standard surfactant is recommended. The cleaning in the ultrasonic bath usually takes two to three minutes. After that the test sieves

are thoroughly rinsed with water and dried. The cleaning with strong bases or acids is generally not recommended.

9.1.1.3 Drying of Test Sieves

Drying ovens of various sizes can be used for drying test sieves (drying temperature < 80 °C).

Additional information concerning ultrasonic cleaning-baths and drying ovens can be found on the Retsch GmbH homepage (<http://www.retsch.com>). Also ask for the free expert guide *Sieve Analysis – Taking a close look at quality*.

NOTICE

N16.0028

Damage of the sieve mesh fabric

Drying temperature > 80 °C

- At higher temperatures, especially fine metal wire meshes can become warped, leading to a reduced tension of the mesh fabric inside the sieve frame and hence, makes the test sieve less efficient during the sieving process.
- **The drying temperature for test sieves must not exceed 80 °C!**

9.2 Wear

⚠ CAUTION

C10.0013

Risk of injury

Improper repairs

- Unauthorised and improper repairs can cause injuries.
- **Repairs to the device may only be carried out by the Retsch GmbH, an authorised representative or by qualified service technicians.**
- **Do not carry out any unauthorised or improper repairs to the device!**

⇒ Check the cork stopper (E) of the sieve lid, as well as the tapping ram (KS) and its O-ring for wear on a regular basis and replace them if necessary.

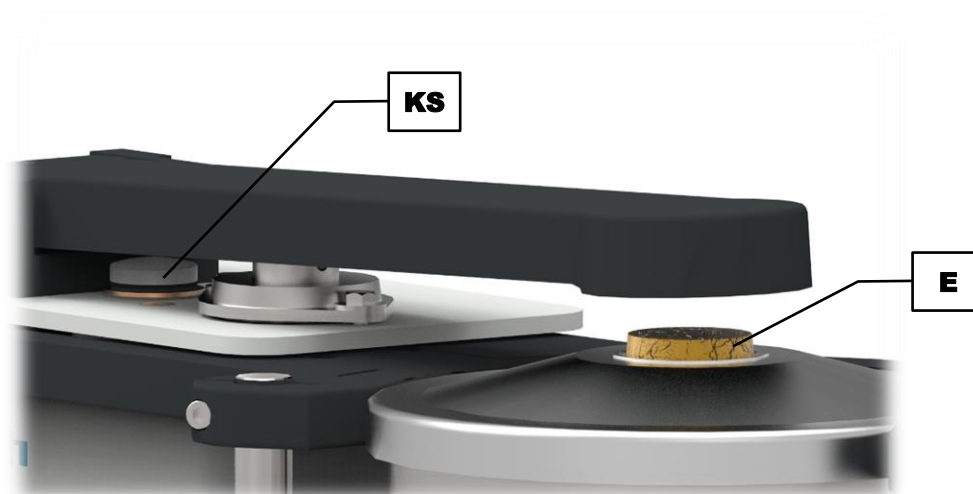

Fig. 15: Tapping ram and cork stopper

Even with the proper handling of the test sieves, a wearing of the sieve mesh fabric depending on the frequency of the sieving operation and on the sample material is unavoidable. The test sieves should be regularly checked for wear and damage and be replaced if necessary.

Likewise, all existing sealing gaskets should be checked for wear on a regular basis and replaced if necessary.

9.3 Maintenance

The AS 200 tap is largely maintenance-free.

10 Accessories

Information on available accessories as well as the respective manuals are accessible directly on the Retsch GmbH homepage (<http://www.retsch.com>) under the heading "Downloads" of the device.

Information on wear parts and small accessories can be found in the Retsch GmbH general catalogue also available on the homepage.

In case of any questions concerning spare parts please contact the Retsch GmbH representative in your country, or Retsch GmbH directly.

10.1 Test Sieves

Decisive for the accuracy and reliability of the measurement result is, in addition to the reproducible operating Tap Sieve Shaker the quality of the test sieve. Test sieves of Retsch GmbH are high quality measuring instruments for which only mesh fabrics and perforated sheets of the corresponding standards are used. Each test sieve is tested five times and is given a serial number, as well as a quality certificate after the final check.



Fig. 16: Test sieves

The different versions of the test sieves of Retsch GmbH are supplied in accordance with all current national and international standards:

- available standards: DIN, ISO, ASTM, BS, NF, CGSB
- available diameters: 100 mm / 150 mm / 200 mm / 203 mm (8") / 305 mm (12") / 400 mm / 450 mm (18")
- available sieve surfaces: sieve mesh fabric (20 µm to 125 mm) and perforated screens (round, elongated or square holes) of stainless steel
- on request with an individual test certificate for the inspection of measuring and testing equipment monitoring according to ISO 9000 ff.

Among the various test sieves matching collecting pans, collecting pans with outlet, intermediate pans, intermediate rings, venting rings and sieve lids are available.

10.1.1 Certificate

Before delivery, each test sieve is optically surveyed according to the standards DIN ISO 3310-1 and ASTM E 11, and provided a certificate of compliance with the order.

On request, an additional acceptance test certificate with a calibration protocol can be provided, documenting the measurement results in tabular and graphical form, hence representing a calibration certificate with more detailed statistics.

10.1.2 Calibration Service

As a special service Retsch GmbH offers the calibration of the test sieves. All relevant information are recorded during the standard measuring process of the test sieve and confirmed in the required certificate.

10.2 Sieving Aids

NOTICE

N17.0027

Damage of the sieve mesh fabric

Use of mechanical sieving aids

- When using mechanical sieving aids, there is a danger that fine sieve mesh fabrics might be damaged.
- **Ensure that no overstretching of the sieve mesh fabric occurs due to overloading with sieving aids.**
- **If in doubt, please contact your local distributor or Retsch GmbH directly.**

By electrostatic and Van-der-Waals forces, as well as by fluid bridges, single particles can combine to form agglomerates. Since in this case not the individual primary particles, but particle collectives are measured, there is a distortion of the particle size distribution (a higher coarse fraction results). In order to prevent the formation of agglomerates or dissolve them, sieving aids can be used.

Mechanical sieving aids:

Mechanical sieving aids cause a destruction of agglomerates and dislodge wedged particles from the sieve meshes. Depending on the mesh size of the test sieve and the preselected amplitude, balls of agate, rubber, steatite or cubes of polyester urethane rubber, and nylon brushes or stainless steel chain rings can be used for this purpose.

NOTICE For very soft sample material, an undesired crushing of primary particles might occur.

Solid additives:

Solid additives, such as talcum or Aerosil® can be admixed to fatty, moist, sticky or oily sample materials. They attach themselves to the particle surface and counteract the formation of agglomerates. Their particle size is so small that they have no sustainable influence to the actual particle size analysis of the sample material. However, the measurement results will be distorted depending on the added amount of additive.

Liquid sieving aids:

Antistatic spray, benzene, alcohol and surfactants can be used as liquid sieving aids, though benzene and alcohol are only to be used during sample preparation. They reduce the electrostatic charges, wash out fatty or oily components of the sample material, or diminish the surface tension in the wet sieving.

11 Disposal

In the case of a disposal, the respective statutory requirements must be observed. In the following, information on the disposal of electrical and electronic devices in the European Community are given.

Within the European Community the disposal of electrically operated devices is regulated by national provisions that are based on the EU Directive 2012/19/EU on Waste Electrical and Electronic Equipment (WEEE).

Accordingly, all devices supplied after August 13th 2005 in the business-to-business area, to which this product is classified, may no longer be disposed of with municipal or household waste. To document this, the devices are provided with the disposal label.

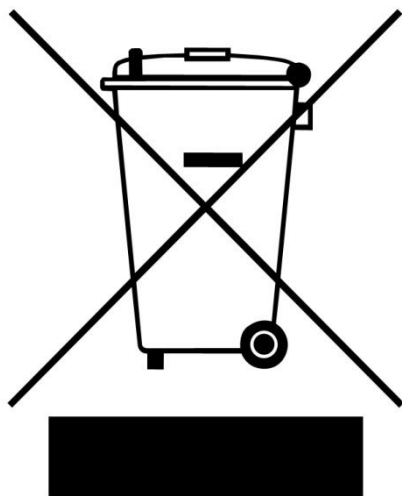

Fig. 17: Disposal label

Since the disposal regulations worldwide and also within the EU may differ from country to country, the supplier of the device should be consulted directly in case of need.

This labelling obligation is applied in Germany since March 23rd 2006. From this date on, the manufacturer must provide an adequate possibility of returning all devices delivered since August 13th 2005. For all devices delivered before August 13th 2005 the end user is responsible for the proper disposal.

12 Index

A

Accessories	38
Ambient temperature	16
Amendment status	6
Amperage	17

B

Back	29
Back view	29
Bar code	18

C

Calibration	34
Calibration service	39
Capacity	17
CE marking	18
Certificate	39
Circular motion	
horizontal	27
Circular motions	14
Clamping lever	28
position	24
Cleaning	35
Complaints	15
Condensation	15
Confirmation form for the managing operator	11
Continuous operation	32
Control unit	28
Controlling the device	31
Copyright	6
Cork stopper	28, 36

D

Degree of protection	12
Depth	13
base	13
Device designation	17
Dimensions	13
Disclaimer	6
Disconnection from the mains	21
Displays	31
Disposal	41
label	41
regulations	41
Disposal label	18
Drive	14

E

EasySieve®	30, 33
Electrical connection	17
Electromagnetic compatibility	13
EMC	13
Emissions	12
Equivalent continuous sound level	12
Evaluation	33
Explanations of the safety instructions	7

External fuse	17
---------------------	----

F

Feed grain size	14
Feed quantity	13
First commissioning	21
Frequency	17
Front	28
Front view	28
Functions	31
Fuse strength	17
Fuse type	17

G

General catalogue	38
General safety instructions	8
Grain size	
range	26

H

Hearing damage	12
Height	13
Humidity	16

I

Installation	15
Installation height	16
Installation site	
conditions	16

L

L _{eq}	12
Lifting the device	19
Location requirements	13
Locking bolt	28
Long-term operation	27

M

Mains connection	29
Mains frequency	17
Mains supply	17
Mains switch	29
Maintenance	11, 34, 35, 37
Manual	6
Manual	8
Manual	11
Manufacturer's address	18
Materials	26
Maximum relative humidity	16
Measurement range	14
Measurement report	33

N

Notes on the manual	6
Number of fractions	
maximum	14

O

Operating controls	31
--------------------------	----

Operating instructions	11	Sieving aids	14, 39
Operating the device	26	Sieving noises	12
Organic solvents	35	Signs	6, 7
P		Small accessories	38
Packaging	15	Software	33
Part number	17	Sound level	12
Particle distribution	33	Sound parameters	12
Particle size analysis	33	Spare parts	38
Particle size characteristics	33	Standby mode	29
Particle size range	14	START	31
Payload	14	STOP	31
Performing a sieving	30	Switching on / off	29
Power version	17	Symbols	6, 7
Principle of operation	27	T	
Process		Tapping arm	28
continue	32	Tapping ram	36
end	32	Taps	14
pause	31	Target group	8
start	31	Technical data	12
stop	31	Temperature fluctuations	15
Programme mode	23	Temperature range	16
P1	22	Temporary storage	15
P2	22	Test sieve	26, 38
Push button	28	cleaning	35
R		diameter	21
Range of application of the device	27	drying	36
Rated power	13	insert	23
Receptacle volume	13	maximum drying temperature	36
Repair	9, 34, 36	selection	30
Repair instructions	9	Time	32
Required floor space	13	setting	31
Return	15	Transport	15
for service and maintenance	34	Transport angles	18
Return device	41	Transport damage	15
Return form	34	Transportation aid	18
RS232 interface	29	install	19
S		Transportation lock	
Safety Officer	8	removing	18
Safety plug		unscrewing	18
connect	22	Type plate	17, 29
connection	22, 29	description	17
Sample quantity		U	
maximum	14	UKCA marking	18
Scale	33	Use of the device for the intended purpose	26
Serial number	18	V	
Service address	9	Views of the device	28
Setting mode	29	Voltage	17
Sieve diameter	14	W	
Sieve lid	28	Warning	
Sieve plate	28	Information	8
position	24	Warranty claim	15
Sieve stack		Warranty claims	9
height	22	Wear	35, 36
insert	24	Wear parts	38
maximum height	14	Weight	13, 17, 19
maximum weight	14	Wet sieving	14
remove	24, 25		

Width.....	13
base.....	13
Workplace related emission level	12

Y	
Year of production.....	17

TAP SIEVE SHAKER

AS 200 tap | 30.025.0001

DECLARATION OF INCORPORATION

We, as represented by the undersigned, hereby declare that the above device is an incomplete machine that is intended to be completed by a safety system to be provided, which meets the basic requirements of the following guidelines:

Machinery Directive 2006/42/EC

Applied standards, in particular:

DIN EN ISO 12100	Machine Safety - General Design Principles
DIN EN 61010-1	Safety Regulations for Electrical Measurement, Control, Regulation and Laboratory Devices

Electromagnetic compatibility 2014/30/EU (tested at 230 V, 50 Hz)

Applied standards, in particular:

EN 55011	Industrial, scientific and medical equipment - Radio-frequency disturbance characteristics - Limits and methods of measurement
DIN EN 61326-1	Electrical equipment for measurement, control and laboratory use - EMC requirements

In particular, the harmonised standards are only met if it is ensured that protective devices against intrusion into the work area from all sides, noise protection and the electrical connections are properly installed.

The commissioning of the incomplete machine is prohibited until it has been completed by the above mentioned components and complies with the regulations of the Machinery Directive, and an EC Declaration of Conformity has been obtained in accordance with Annex II Part A.

Furthermore, we declare that the relevant technical documents for the above device have been created in accordance with Annex VII, Part B of the Machinery Directive and we undertake to present these documents to the European Securities and Markets Authority (ESMA) upon request.

Authorized person for the compilation of technical documents:

Julia Kürten (Technical Documentation)

In case of a modification of the device not previously agreed with Retsch GmbH, as well as the use of unauthorised spare parts or accessories, this declaration will lose its validity.

Retsch GmbH

Haan, 09/2023



Dr. Frank Janetta, Head of Development



Retsch[®]

Copyright

© Copyright by
Retsch GmbH
Retsch-Allee 1-5
42781 Haan
Germany